



Product Catalogue 2015/2016

Elastic conveyor belts,
flat belt accessories,
V- and Round belts and
advanced welding equipment



2

ABOUT US

The Company – “The 3 principals of Beha” – We focus on our customers – Top Quality is our target – Contact – Innovations – Materials and application areas – Product Group Overview

14

CONVEYOR BELT PROFILES MADE OF PU AND TPE

Table structure key – Roundbelts – V-belts – Top covers
Twin-V-Belts – Ridge-top-V-belts – T-Profiles – Special profiles

50

CUSTOM-MADE PROFILES

YOUR custom-made profiles – Technical Inquiry

55

BELT FABRICATION & MECHANICAL FASTENERS

Express service fabrication – Mechanical fasteners

60

ELASTIC CONVEYOR BELTS & TRACKING PROFILES

Elastic conveyor belts 700 mm – Top cover films
V-guides – Belt edges – Cleats – PU flex sidewalls

76

WELDING TOOLS & CONTROLLERS FOR CONVEYOR BELT VULCANIZERS

Welding tools and accessories

96

KNOW-HOW

Know-how PU and TPE – General directives for plastics – Calculation examples
LubeSite® Lubricators – BEHA worldwide Group of companies

ABOUT US

Beha Innovation GmbH is a German company based in the heart of Europe. We extrude a complete line of the highest quality Polyurethane and Polyester profiles for transport and drive applications. True to the motto “smart conveying solutions”, we have been supplying innovative drive and conveying technology products for over 40 years. We provide quick and accurate service through our main factory in Glottertal Germany, our subsidiary located in USA, as well as our worldwide distribution network.



The company



“The 3 principals of BEHA”

People

Quality and innovations are produced by people – our colleagues, our customers and our suppliers.

Quality

High quality raw materials and quality-oriented manufacturing processes result in consistently high quality products. Quality communication and teamwork for continued mutual success!

Innovation

We have deep insight into the applications through customers and our suppliers. We are always developing innovative products and solutions for our customers on this basis and with our know-how.



We focus on our customers

“We put innovative ideas into practice.”



Our success is based on knowledge of the market and serving our customers with a broad line of profiles and belts. Our strategy is to provide the best extruded profiles and homogeneous belts in the market today and lead the industry in new innovative products in the future. Our in house tool shop allows us to react quickly to changing demands in the market. This strategy has resulted in a complete range of high quality products where we hold International trade mark rights and patents.

Top Quality is our target

Our customer service people are linked closely with our customers in the market and work together with them to provide the fastest and most accurate handling of inquiries and orders. We employ a sophisticated logistic process that ensures highest quality of service – worldwide. All procedures and activities are conducted with the highest possible commitment to quality. We comply with the specification of the standard DIN EN ISO 9001.

BEHAbelt NEWSLETTER

Subscribe to our newsletter and always stay up to date on our latest innovations and products!

www.behabelt.com



Contact

Technical Consulting



Katrin Tüllmann

Phone +49 (0) 7684/907 - 160

Fax: +49 (0) 7684/907 - 101

E-mail: katrin.tuellmann@behabelt.com



Jürgen Strecker

Phone +49 (0) 7684/907 - 152

Fax: +49 (0) 7684/907 - 101

E-mail: juergen.strecker@behabelt.com



Carmen Gaiser

Phone +49 (0) 7684/907 - 150

Fax: +49 (0) 7684/907 - 101

E-mail: carmen.gaiser@behabelt.com



Maria Caputo

Phone +49 (0) 7684/907 - 114

Fax: +49 (0) 7684/907 - 101

E-mail: maria.caputo@behabelt.com



Jürgen Gohlke (Sales Representative)

Phone.: +49 (0) 7684/ 907 - 120

Fax: +49 (0) 7684/907 - 101

E-mail: juergen.gohlke@behabelt.com

Technical Consulting

BEHAbelt supports you with a competent team which has a solid foundation of technical knowledge.

Contact our experienced team for technical consulting and support with regard to belt profiles, belts and welding technology!



Innovations

Elastic conveyors up to 700 mm wide

New surfaces - endless fabricated belts

Starting on page 60

Flat belt stripes for sidewalls

BEHAbelt offers flat belt material cut to width and length, suitable for welding various height and thickness side walls directly to the conveyor belt.

Starting on page 66

Special welding paddle for flat belts

BEHAbelt offers a special welding paddle with the geometry required for butt welding flat belt material with a welded width of up to 60mm with the corresponding geometry. **Starting on page 82**

Guide clamp FZ02/3F for flat belts

Flat belt width max. 60mm and height 1.6 -5mm. The simplest welding method!

Page 84

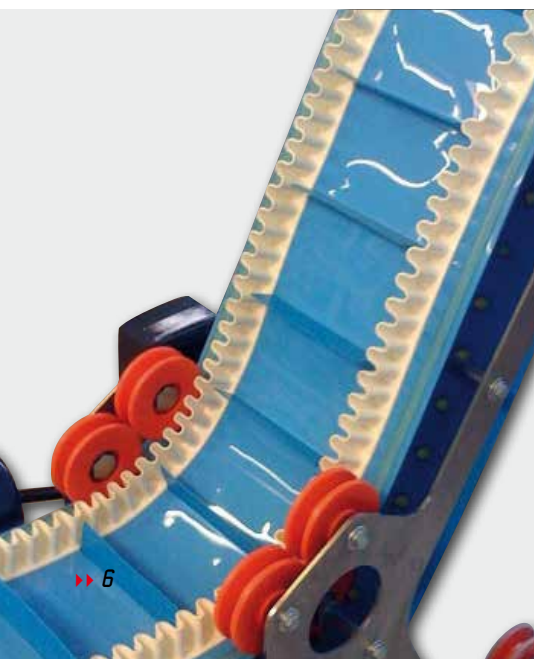



BEHA belt PUtex replaces Linatex rubber coatings

BEHA belt PUtex - similar to rubber coatings, however, fully welded and has excellent properties to avoid delamination of the coating. BEHA belt PUtex is the perfect alternative to rubber.

Page 66

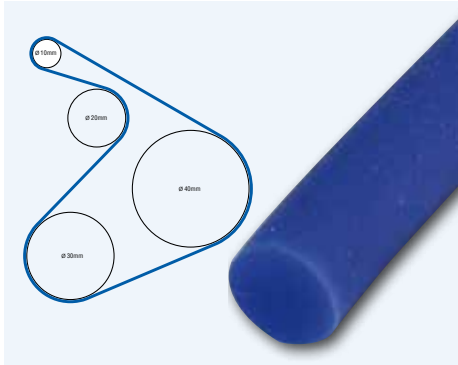

BEHA belt PUsoft - Flexible and high grip

BEHA belt PUsoft - the highly flexible, high grip and durable solution for applications with small pulley diameters. The unique and extremely soft PU blend by BEHA belt combines excellent grip properties due to the high coefficient of friction with simultaneously low abrasion. BEHA belt PUsoft – THE alternative to silicon.

Page 17



PJ ribbed V-belt for roller conveyors

The BEHA belt Flex® PJ V-belts are used wherever standard lengths don't match your design (centre distance).

Page 35

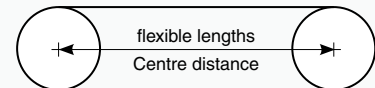

T-profile with textured surface

T-profile PU 85 A (25x5 mm), a standard profile for packaging applications.

Page 45

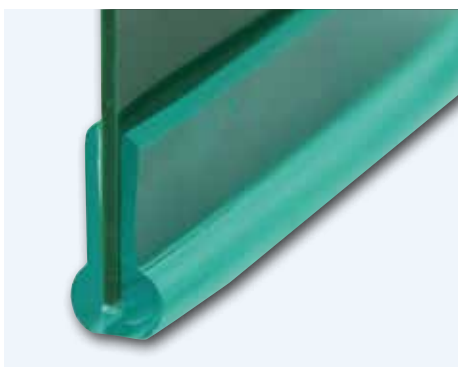

Belt edges

New belt edges for perfectly guided conveyor curves.

Page 70



Innovations



Unique control panel for one-handed operation



PATENT
pending

INDUSTRIE
PREIS 2014
BEST OF



Fiberglass-reinforced ergonomic housing

Works. Simple. Safe.

EERGO

Specifically developed welding tool for PU and TPE

Page 80

FZ01 Vario with exchangeable profile jaws

Page 85

With the exchangeable profile jaws option, the robust metal version of the proven FZ01 guide clamp for smaller profiles also allows for precise and reliable welding of custom profile geometries.

Bench vise with ball joint for EERgo

Page 87

Mount your EERgo welding tool on a flexible, ball-bearing mounted holder to simplify stationary connecting of your belt profile.

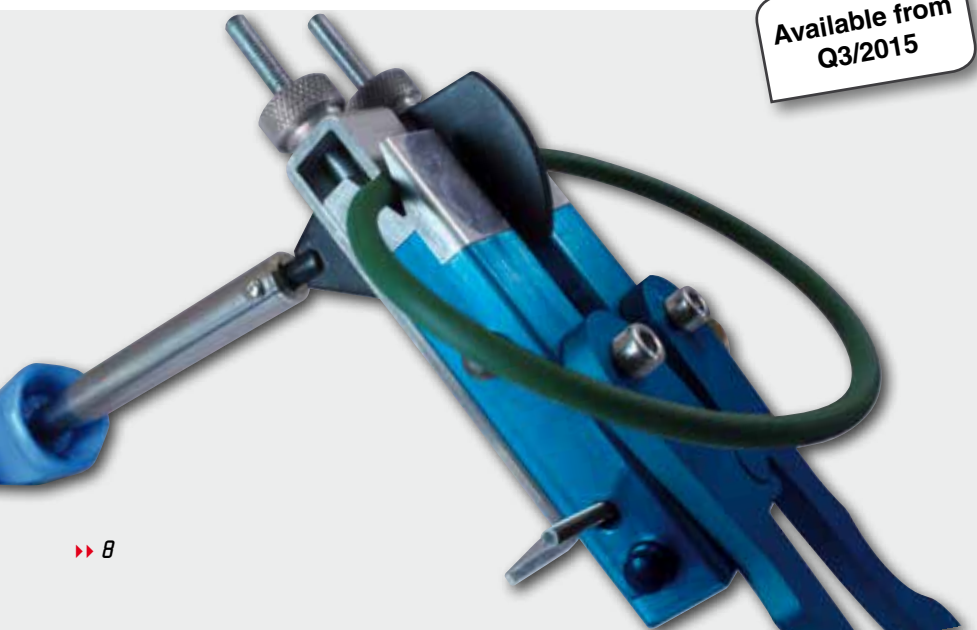

Available from
Q3/2015



NEW concept! CRIMP* CONNECTING for steel cables

Page 91

A connection which lasts! With the right tool and additional outer jacket, you can achieve a reliable and flexible connection.

Easy to use – flawless crimping of steel cables!

*Ferrules



NEW connection methods for conveyor belts! Page 58/59

Become your own technician!
With the new fastener solution for
round belts and the belt fastener
for V-belts!



Welding service for elastic flat belts, available in a range of versions to match your needs and requirements.

- Butt weld hot press (neo)
- Butt weld hot paddle (endwise)
- Finger-joint hot press (standard)



Example: Butt weld hot paddle
(endwise)

Learn more on page 57

Materials and application areas

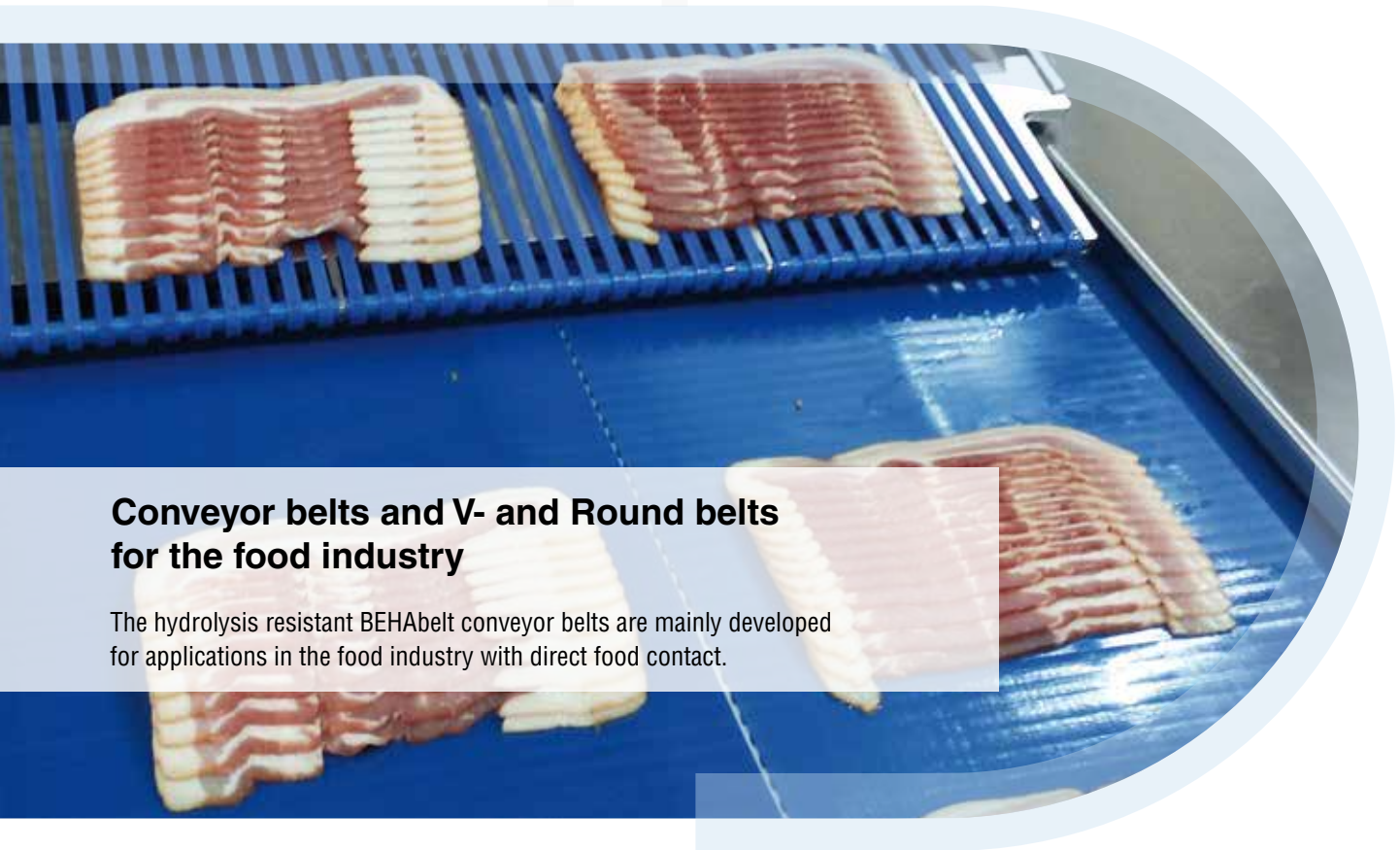

Conveyor belts and V- and Round belts for the food industry

The hydrolysis resistant BEHAbelt conveyor belts are mainly developed for applications in the food industry with direct food contact.

Important characteristics

- FDA/EC compliant
- Especially high durability in wet areas.
- Very good hydrolysis resistance and stability against Microbes.
- Very good weldability.
- All Round- and V-Belts also available with reinforcement on request.
- Available with smooth and rough surface
- All BEHAbelt belts in PU 80 A transparent/orange and TPE Polyester of the standard delivery programme are also suitable for applications in the food industry.

Materials/Quality

- PU 70 A (approx. 76° Shore A) ultramarine blue/transparent
- PU 75 A (approx. 80° Shore A) sky blue
- PU 80 A (approx. 84° Shore A) ultramarine blue/transparent/orange
- PU 85 A (approx. 88° Shore A) sapphire
- TPE 40D/55D
- Special profiles and further materials on request

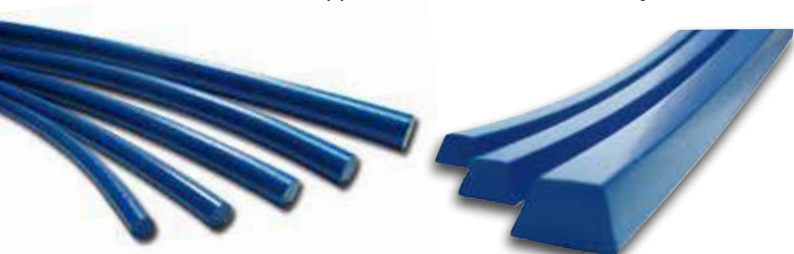



Size sorting of olives

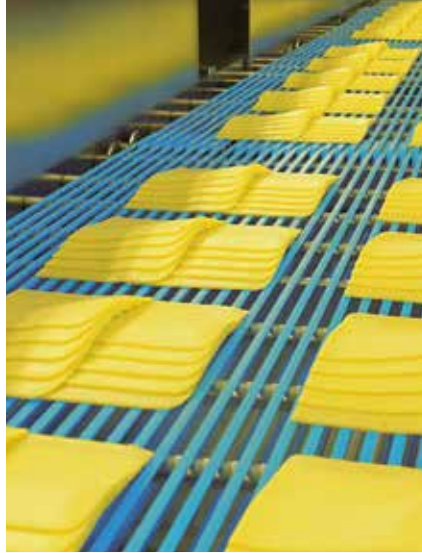

Transport of cheese slices



Packaging system with T-Profile



Metal detectable profiles and conveyor belts

Fast moving Polyurethane conveyor belts in the food processing industry are subject to wear and abrasion. The BEHA-belt FDA compliant belt is manufactured in an easy identifiable blue colour, so that it is clearly visible if a small particle

gets into the food during the production process. BEHA belt introduces a new product range of metal detectable food grade belting to take food processors to the next step in food safety. PU80A Safe belts are made of a special thermo-

plastic recipe that allows very small particles to be detected by most standard metal detection equipment used in the food industry.

Metal detection with PU 80A SAFE

- FDA/EC compliant
- For dry and wet food applications.
- Allows extremely small pieces to be detected.
- Ensures food safety by reducing the risk of contamination.

PU SAFE range

- PU 80A SAFE round and V-belts
- PU 80A SAFE homogeneous conveyor belts
- PU 70A SAFE V-Guides
- PU 90A SAFE cleats
- PU 80 A SAFE sidewalls

Applications / Overview

- Especially for the requirements in the food industry we have added homogeneous conveyor belts and completed our range with detectable cleats and guiding profiles. Therefore they also meet the high standards and requirements of HACCP.

General directives for plastics with direct food contact

There are several country-specific and global directives for the application of food contact materials. In general, all food contact materials have to be produced according to the principles of Good Manufacturing Practice (avoiding the occurrence of a health hazard or any other unacceptable change in the composition of the food during its intended use).

of their approval of raw materials in a processed or finished state, and also specified the conditions under which the approval is valid.

the evidence of the global and specific migration. This can be requested and interpreted differently depending on the application.

FDA Guideline "Title 21: Code of Federal Regulations"

The Food and Drug Administration of the Public Health Service of America is the world's best-known authority involved in consumer protection in respect of potential detrimental influences. The FDA has prepared a review "Title 21: Code of Federal Regulations" in respect

EC Directive 1935/2004, EU Directive No. 10/2011

The framework Regulation EC 1935/2004 (EU Directive No. 10/2011) Food Contact and belonging specific Directive 2002/72/EC Monomers Additives of the European Parliament regulates plastics intended to come into contact with foodstuffs. The EU legislation for food contact materials is based on positive lists of the substances and maximum limits of migration into food. Only substance on these positive lists may be used for manufacturing plastics that are designated to have food contact. Furthermore, you have to show

BfR "Plastics Recommendations" for use in the food industry

The German Federal Institute for Risk Assessment (BfR, formerly BgVV) was founded to strengthen the consumer health protection and frames scientific opinions on possible health risks of substances which have food contact.

Those recommendations are listed in the framework of the Food and Feed Code (LFGB), known as the "Plastics Regulations".

Product groups

Features	PU 60 A		PU 65 A		PU 70 A		PU 75 A		PU 80 A	
	Profile	FB	Profile	FB	Profile	FB	Profile	FB	Profile	FB
available versions										
Width/mm		140		140/ 700				140/ 700		140/ 700
Reinforcement							●		●	
FDA/EC compliant	●	●	●	●	●		●	●	●	●
reinforced glass fiber							●			
PLUS-Material							●			
Rough									●	
Special surfaces								●		●
Mechanical										
Good grip	●	●	●	●	●		●	●		
Accumulation										
Chemical										
Microbial and hydrolysis resistant	●	●	●	●			●	●	●	
Physical										
Metal detectable					●				●	●
Antistatic										
Application area/ Special features	<p>Take a look at our special "PUsoft" and "PUTex" versions. PUsoft is suitable for small pulleys (10mm) and PUTex is an alternative to the "Linatex" rubber coating.</p> <p>This is an outstanding coating material choice, since it ensures excellent grip properties.</p>				<p>Our wedge profiles are made from this material grade and are available specifically for small pulley sizes (food industry).</p>		<p>Our standard grade material is often used in the following industries: Furniture, painting lines, solar technology, roof tiles etc. This material grade is distinguished by its sanitary, cleanability and flexibility properties and is ideally suited to the food industry.</p>			



PUTex-Coating -
perfect alternative for rubber



Transport system for ham

Overview

Features	PU 85 A		PU 90 A		PU 95 A		TPE 40/55 D		TPE 63 D	
	Profile	FB	Profile	FB	Profile	FB	Profile	FB	Profile	FB
available versions										
Width/inch		140	●			700		700 (only TPE 55 D)		
Reinforcement	●		●		●		●		●	
FDA/EC compliant	●					●	●	●	●	
reinforced glass fiber	●									
PLUS-Material	●									
Rough	●									
Special surfaces							●	●		
Mechanical										
Good grip										
Accumulation			●		●	●	●	●	●	
Chemical										
Microbial and hydrolysis resistant	●					●	●	●	●	
Physical										
Metal detectable										
Antistatic	●									
Application area/ Special features	Wood industry, furniture industry, commercial kitchens, paper and printing processing, bowling alley equipment, electronics industry.		Hardness and abrasion values designed specifically for the ceramics and tile industries, brick industry and other harsh conditions.			Canning industry, Roller conveyors and other mechanically demanding applications.				



Tray transport in canteen



Brick production



Canning transport system





CONVEYOR BELT PROFILES MADE OF PU AND TPE

BEHAbelt is your complete source for top quality Polyurethane and Polyester profile belts and accessories. We offer a complete line of V-belts and Round belts, as well as an extensive selection of special profiles and materials that can be customized to fit your requirements.



Table structure key.....	16
Round belts, hollow round belts, twisted round belts.....	17
V-belts	32
Coatings.....	39
Twin-V-Belts	40
Ridge-top-V-belts	41
T-Profiles	44
Special profiles	46
Cornbelt	46
U-Profile, Square-Profile, V-belt with valuted top.....	47
V-belt 3-ribbed, Round belt reinforced aramid	48
V-belt with chamfer (for roller conveyor)	49

Table structure key

General explanation of the product tables



PU 85 A green rough, reinforcement aramid ②

④
⑤

approx. 88° Shore A

Recommended pretension 1...2 %

Order No.	⑦ Diameter		⑧ Cross section	⑨ approx. weight kg/100 m	⑩ Standard Roll		⑪ Recommended Min. pulley \varnothing		⑫ Fmax/belt (Standard)*		⑬ Fmax/belt (overlap)	
	mm	inch			cm ²	m	ft	mm	inch	kg	lbs	kg
① 8ZR85A060RA	6,0	7/32	0,283	3,4	100	328	60	2,3	10,2	22,4	30,6	67,3
FBZR85A063RA	6,3	1/4	0,310	3,8	100	328	65	2,5	11,2	24,6	33,6	73,9
FBZR85A070RA	7,0	9/32	0,385	4,7	100	328	70	2,8	13,8	30,4	41,4	91,1
FBZR85A080RA	8,0	5/16	0,500	6,0	100	328	80	3,2	18,0	39,6	54,0	118,8
FBZR85A095RA	9,5	3/8	0,710	8,5	100	328	95	3,7	25,4	55,9	76,2	167,6

⑥ Coefficient of friction μ : Steel: approx. 0,45 | PE: approx. 0,30 | HDPE: approx. 0,35

* = coefficient of friction μ :0,5

Key

- ① BEHAbelt article/order number (availability, lead time and minimum order quantity upon request)
- ② BEHAbelt Material Type Quality
- ③ Colour (caution, original colour may deviate from the graphic)
- ④ Specified Shore hardness (Attention! BEHAbelt Material Type Quality doesn't match the Shore hardness of the belt)
- ⑤ Recommended pretension to tighten the belt in the system (in %)
- ⑥ Coefficient of friction μ on steel, PE and HDPE surfaces (Also see coefficient of friction values page 106)
- ⑦ Profile geometry in mm
- ⑧ Material cross-section of the profile (For further details on the calculation, see page 106)
- ⑨ Approx. weight in kg for 100 m of the corresponding profile geometry
- ⑩ Standard roll = Manufacturing unit (smaller amounts available at an upcharge). (Special roll sizes upon request)
- ⑪ Recommended minimum pulley diameter (in mm)
Smaller pulley diameters reduce lifetime of the belt
- ⑫ Approx. max. load of the belt at a coefficient of friction μ :0.5 (standard case) for butt welding (in kg/belt)
- ⑬ Approx. max. load of the belt at a coefficient of friction μ :0.5 (standard case) for overlap welding (in kg/belt)
(hot-press method HP01, overlap length of 60 mm)

Symbols

antistatic

Anti-static dissipative profile with outstanding mechanical properties



Profile with exceptional low-temperature flexibility down to -30°C.

PATENT
LOW ELONGATION

Patented blend of materials "PLUS" in order to optimise elongation for quality PU75A and PU85A for critical applications.



Very good UV resistance.
Available in black and silver.



FDA/EC conformity for hydrolysis-resistant conveying profiles with rough and finely textured surfaces.
EC/FDA/USDA conformity for smooth profiles.

SAFE
Metal detectable

Metal-detectable profiles for a high degree of food safety.



approx. 65° Shore A

Recommended pretension
5...10 %

PU soft blue smooth



Order No.	Diameter \varnothing		Cross Section cm ²	approx. Weight kg/100 m	Standard Roll		Recommended Min. pulley \varnothing		Fmax/belt (Standard)*	
	mm	inch			m	ft	mm	inch	kg	lbs
FBRF030LGS	3,0	1/8	0,071	0,9	200	656	10	0,4	0,9	2,0
FBRF040LGS	4,0	5/32	0,126	1,6	200	656	20	0,8	1,5	3,3
FBRF050LGS	5,0	1/5	0,181	2,2	100	328	30	1,2	2,2	4,9
FBRF060LGS	6,0	7/32	0,283	3,4	100	328	40	1,6	3,4	7,5

Coefficient of friction μ : Steel: approx. 0,90 | PE: approx. 0,55 | HDPE: approx. 0,50 | **FDA/EC compliant**

* = coefficient of friction μ :0,5



approx. 76° Shore A

Recommended pretension
4...8 %

PU 70 A ultramarine blue smooth



Order No.	Diameter \varnothing		Cross Section cm ²	approx. Weight kg/100 m	Standard Roll		Recommended Min. pulley \varnothing		Fmax/belt (Standard)*	
	mm	inch			m	ft	mm	inch	kg	lbs
FBRH030LG	3,0	1/8	0,071	0,9	200	656	15	0,6	1,4	3,1
FBRH040LG	4,0	5/32	0,126	1,6	200	656	25	1,0	2,5	5,5
FBRH048LG	4,8	3/16	0,181	2,2	200	656	30	1,2	3,5	7,7
FBRH050LG	5,0	1/5	0,181	2,2	100	328	35	1,4	3,6	7,9
FBRH060LG	6,0	7/32	0,283	3,4	100	328	45	1,8	5,6	12,3

Coefficient of friction μ : Steel: approx. 0,75 | PE: approx. 0,40 | HDPE: approx. 0,35 | **FDA/EC/USDA compliant**

* = coefficient of friction μ :0,5



approx. 76° Shore A

Recommended pretension
8...10 %

Twisted round belts PU 70 A sky blue smooth



Order No.	Diameter \varnothing		Recommended Min. pulley \varnothing		Fmax/belt (Standard)*	
	mm	inch	mm	inch	kg	lbs
FBXH3X250LG... FBXH3X710LG	5,0	1/5	40	1,6	2,6	5,8

Available standard lengths of 250...710 mm



Coefficient of friction μ : Steel: approx. 0,75 | **FDA/EC/USDA compliant**

* = coefficient of friction μ :0,5



approx. 80° Shore A

Recommended pretension
6...8 %

Twisted round belts PU 75 A PLUS orange smooth (matt)

Order No.	Diameter \varnothing		Recommended Min. pulley \varnothing		Fmax/belt (Standard)*	
	mm	inch	mm	inch	kg	lbs
FBXI3X2500G... FBXI3X4500G	5,0	1/5	40	1,6	5,9	13,0

Available standard lengths of 250...710 mm



Coefficient of friction μ : Steel: approx. 0,70

* = coefficient of friction μ :0,5



Measure the correct belt length tip to tip (production length Lf), without the hook

Construction: 2 x \varnothing 3 mm (\varnothing 5 mm)

Round belts | Shore 80 A



approx. 80° Shore A

Recommended pretension
4...8 %

Coefficient of friction μ

Steel	approx. 0,70
PE	approx. 0,40
HDPE	approx. 0,35

FDA/EC/USDA compliant

PU 75 A sky blue smooth

Order No.	Diameter \varnothing		Cross Section cm ²	approx. Weight kg/100 m	Standard Roll		Recommended Min. pulley \varnothing		Fmax/belt (Standard)*	
	mm	inch			m	ft	mm	inch	kg	lbs
FBRP75A020HI	2,0	5/64	0,032	0,5	200	656	10	0,4	0,8	1,8
FBRP75A030HI	3,0	1/8	0,071	0,9	200	656	20	0,8	1,8	4,0
FBRP75A040HI	4,0	5/32	0,126	1,6	200	656	30	1,2	3,0	6,6
FBRP75A048HI	4,8	3/16	0,181	2,2	200	656	35	1,4	4,4	9,7
FBRP75A050HI	5,0	1/5	0,197	2,4	100	328	40	1,6	4,8	10,6
FBRP75A060HI	6,0	7/32	0,283	3,4	100	328	50	2,0	6,8	15,0
FBRP75A063HI	6,3	1/4	0,310	3,8	100	328	55	2,2	7,4	16,3
FBRP75A070HI	7,0	9/32	0,385	4,7	100	328	60	2,4	9,2	20,2
FBRP75A080HI	8,0	5/16	0,500	6,0	100	328	65	2,6	12,0	26,4
FBRP75A095HI	9,5	3/8	0,710	8,5	100	328	75	3,0	17,0	37,4
FBRP75A100HI	10,0	7/16	0,785	9,4	50	164	80	3,2	18,8	41,4
FBRP75A120HI	12,0	15/32	1,130	13,5	50	164	90	3,5	27,2	59,8
FBRP75A125HI	12,5	1/2	1,230	14,8	50	164	100	3,9	29,6	65,1
FBRP75A150HI	15,0	19/32	1,770	21,5	50	164	120	4,7	42,4	93,3

* = coefficient of friction μ :0,5



approx. 80° Shore A

Recommended pretension
4...8 %

Coefficient of friction μ

Steel	approx. 0,70
PE	approx. 0,40
HDPE	approx. 0,35

PU 75 A red smooth

Order No.	Diameter \varnothing		Cross Section cm ²	approx. Weight kg/100 m	Standard Roll		Recommended Min. pulley \varnothing		Fmax/belt (Standard)*	
	mm	inch			m	ft	mm	inch	kg	lbs
FBRP75A020	2,0	5/64	0,032	0,5	200	656	10	0,4	0,8	1,8
FBRP75A030	3,0	1/8	0,071	0,9	200	656	20	0,8	1,8	4,0
FBRP75A040	4,0	5/32	0,126	1,6	200	656	30	1,2	3,1	6,8
FBRP75A048	4,8	3/16	0,181	2,2	200	656	35	1,4	4,5	9,9
FBRP75A050	5,0	1/5	0,197	2,4	100	328	40	1,6	4,9	10,8
FBRP75A060	6,0	7/32	0,283	3,4	100	328	50	2,0	7,3	16,1
FBRP75A063	6,3	1/4	0,310	3,8	100	328	55	2,2	8,0	17,6
FBRP75A070	7,0	9/32	0,385	4,7	100	328	60	2,4	9,8	21,6
FBRP75A080	8,0	5/16	0,500	6,0	100	328	65	2,6	12,9	28,4
FBRP75A095	9,5	3/8	0,710	8,5	100	328	75	3,0	18,0	39,6
FBRP75A100	10,0	7/16	0,785	9,4	50	164	80	3,2	19,6	43,1
FBRP75A120	12,0	15/32	1,130	13,5	50	164	90	3,5	29,4	64,7
FBRP75A125	12,5	1/2	1,230	14,8	50	164	100	3,9	31,4	69,1
FBRP75A150	15,0	19/32	1,770	21,5	50	164	120	4,7	45,1	99,2
FBRP75A180	18,0	3/4	2,54	31,0	50	164	150	5,9	64,7	142,3
FBRP75A200	20,0	25/32	3,14	40,0	50	164	170	6,7	80,4	176,9

* = coefficient of friction μ :0,5

Brown on request

PATENT
LOW ELONGATION



approx. 80° Shore A

Recommended pretension
3...6 %

Coefficient of friction μ

Steel	approx. 0,70
PE	approx. 0,40
HDPE	approx. 0,35

PU 75 A PLUS orange matt finish

Order No.	Diameter \varnothing		Cross Section cm ²	approx. Weight kg/100 m	Standard Roll		Recommended Min. pulley \varnothing		Fmax/belt (Standard)*	
	mm	inch			m	ft	mm	inch	kg	lbs
FBRI0200G	2,0	5/64	0,032	0,5	200	656	10	0,4	0,9	2,0
FBRI0300G	3,0	1/8	0,071	0,9	200	656	20	0,8	1,8	4,0
FBRI0400G	4,0	5/32	0,126	1,6	200	656	30	1,2	3,6	7,9
FBRI0480G	4,8	3/16	0,181	2,2	200	656	35	1,4	5,2	11,4
FBRI0500G	5,0	1/5	0,197	2,4	100	328	40	1,6	5,7	12,5
FBRI0600G	6,0	7/32	0,283	3,4	100	328	50	2,0	8,1	17,8
FBRI0630G	6,3	1/4	0,310	3,8	100	328	55	2,2	8,9	19,6
FBRI0700G	7,0	9/32	0,385	4,7	100	328	60	2,4	11,1	24,4
FBRI0800G	8,0	5/16	0,500	6,0	100	328	65	2,6	14,4	31,7
FBRI0950G	9,5	3/8	0,710	8,5	100	328	75	3,0	20,4	44,9
FBRI1000G	10,0	7/16	0,785	9,4	50	164	80	3,2	22,6	49,7

* = coefficient of friction $\mu:0,5$

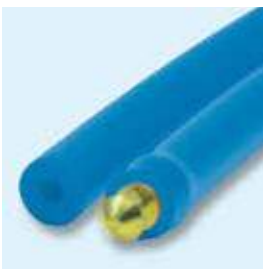

approx. 80° Shore A

Recommended pretension:
welded 4...8 %
Fitting connector max. 3...6 %

PU 75 A sky blue smooth hollow round belt

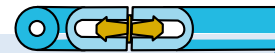

Order No.	Diameter \varnothing		Cross Section cm ²	approx. Weight kg/100 m	Standard Roll		Recommended Min. pulley \varnothing		Fmax/belt (Standard)*	
	Outside	Inside			m	ft	mm	inch	kg	lbs
FBHP75A048HI	4,8	1,8	0,147	1,8	200	656	30	1,2	3,6	7,9
FBHP75A063HI	6,3	2,5	0,261	3,2	100	328	45	1,8	6,2	13,6
FBHP75A080HI	8,0	3,2	0,420	5,1	100	328	55	2,2	10,0	22,2
FBHP75A095HI	9,5	3,8	0,600	7,2	100	328	65	2,6	14,4	31,7
FBHP75A125HI	12,5	5,2	1,020	12,4	50	164	85	3,4	24,4	53,7
FBHP75A150HI	15,0	5,2	1,560	19,0	50	164	100	4,0	37,4	82,3

Coefficient of friction μ : Steel: approx. 0,70 | PE: approx. 0,40 | HDPE: approx. 0,35 | FDA/EC/USDA compliant

* = coefficient of friction $\mu:0,5$



approx. 80° Shore A

Recommended pretension:
welded 4...8 %
Fitting connector max. 3...6 %

PU 75 A red smooth hollow round belt

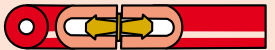

Order No.	Diameter \varnothing		Cross Section cm ²	approx. Weight kg/100 m	Standard Roll		Recommended Min. pulley \varnothing		Fmax/belt (Standard)*	
	Outside	Inside			m	ft	mm	inch	kg	lbs
FBHP75A048	4,8	1,8	0,147	1,8	200	656	30	1,2	3,7	8,1
FBHP75A063	6,3	2,5	0,261	3,2	100	328	45	1,8	6,7	14,7
FBHP75A080	8,0	3,2	0,420	5,1	100	328	55	2,2	10,8	23,8
FBHP75A095	9,5	3,8	0,600	7,2	100	328	65	2,6	15,3	33,7
FBHP75A125	12,5	5,2	1,020	12,4	50	164	85	3,4	26,1	57,4
FBHP75A150	15,0	5,2	1,560	19,0	50	164	100	4,0	39,6	87,1

Coefficient of friction μ : Steel: approx. 0,70 | PE: approx. 0,40 | HDPE: approx. 0,35

* = coefficient of friction $\mu:0,5$

For suitable fitting connectors and information how to use them please refer to page 59.

Round belts | Shore 84 A



PU 80 A ultramarine blue smooth



approx. 84° Shore A
Recommended pretension
4...8 %

Coefficient of friction μ	
Steel	approx. 0,65
PE	approx. 0,35
HDPE	approx. 0,30
FDA/EC/USDA compliant	

Order No.	Diameter \varnothing		Cross Section cm ²	approx. Weight kg/100 m	Standard Roll		Recommended Min. pulley \varnothing		Fmax/belt (Standard)*	
	mm	inch			m	ft	mm	inch	kg	lbs
FBRP80A020UB	2,0	5/64	0,032	0,5	200	656	15	0,6	0,9	2,0
FBRP80A030UB	3,0	1/8	0,071	0,9	200	656	25	1,0	2,2	4,8
FBRP80A040UB	4,0	5/32	0,126	1,6	200	656	30	1,2	3,9	8,6
FBRP80A048UB	4,8	3/16	0,181	2,2	200	656	40	1,6	5,5	12,1
FBRP80A050UB	5,0	1/5	0,197	2,4	100	328	45	1,8	6,1	13,4
FBRP80A060UB	6,0	7/32	0,283	3,4	100	328	55	2,2	8,7	19,1
FBRP80A063UB	6,3	1/4	0,310	3,8	100	328	60	2,4	9,6	21,1
FBRP80A070UB	7,0	9/32	0,385	4,7	100	328	65	2,6	11,8	26,0
FBRP80A080UB	8,0	5/16	0,500	6,0	100	328	75	3,0	15,3	33,7
FBRP80A095UB	9,5	3/8	0,710	8,5	100	328	90	3,6	21,6	47,5
FBRP80A100UB	10,0	7/16	0,785	9,4	50	164	95	3,8	24,0	52,8
FBRP80A120UB	12,0	15/32	1,130	13,5	50	164	110	4,4	34,4	75,7
FBRP80A125UB	12,5	1/2	1,230	14,8	50	164	115	4,6	37,5	82,5
FBRP80A150UB	15,0	19/32	1,770	21,5	50	164	140	5,5	54,1	119,0

* = coefficient of friction $\mu:0,5$



PU 80 A ultramarine blue lightly rough



approx. 84° Shore A
Recommended pretension
4...8 %

Coefficient of friction μ	
Steel	approx. 0,55
PE	approx. 0,30
HDPE	approx. 0,25
FDA/EC compliant	

Order No.	Diameter \varnothing		Cross Section cm ²	approx. Weight kg/100 m	Standard Roll		Recommended Min. pulley \varnothing		Fmax/belt (Standard)*	
	mm	inch			m	ft	mm	inch	kg	lbs
FBRP80A020BA	2,0	5/64	0,032	0,5	200	656	15	0,6	0,9	2,0
FBRP80A030BA	3,0	1/8	0,071	0,9	200	656	25	1,0	2,2	4,8
FBRP80A040BA	4,0	5/32	0,126	1,6	200	656	30	1,2	3,9	8,6
FBRP80A048BA	4,8	3/16	0,181	2,2	200	656	40	1,6	5,5	12,1
FBRP80A050BA	5,0	1/5	0,197	2,4	100	328	45	1,8	6,1	13,4
FBRP80A060BA	6,0	7/32	0,283	3,4	100	328	55	2,2	8,7	19,1
FBRP80A063BA	6,3	1/4	0,310	3,8	100	328	60	2,4	9,6	21,1
FBRP80A070BA	7,0	9/32	0,385	4,7	100	328	65	2,6	11,8	26,0
FBRP80A080BA	8,0	5/16	0,500	6,0	100	328	75	3,0	15,3	33,7
FBRP80A095BA	9,5	3/8	0,710	8,5	100	328	90	3,6	21,6	47,5
FBRP80A100BA	10,0	7/16	0,785	9,4	50	164	95	3,8	24,0	52,8
FBRP80A120BA	12,0	15/32	1,130	13,5	50	164	110	4,4	34,4	75,7
FBRP80A125BA	12,5	1/2	1,230	14,8	50	164	115	4,6	37,5	82,5
FBRP80A150BA	15,0	19/32	1,770	21,5	50	164	140	5,5	54,1	119,0

* = coefficient of friction $\mu:0,5$

SAFE

Metal detectable



approx. 84° Shore A

Recommended pretension
3...6 %

Coefficient of friction μ

Steel	approx. 0,65
PE	approx. 0,35
HDPE	approx. 0,30

FDA/EC/USDA compliant

PU 80 A SAFE capri blue smooth



Order No.	Diameter \varnothing		Cross Section cm ²	approx. Weight kg/100 m	Standard Roll		Recommended Min. pulley \varnothing		Fmax/belt (Standard)*	
	mm	inch			m	ft	mm	inch	kg	lbs
FBRJ020LGM	2,0	5/64	0,032	0,5	200	656	15	0,6	0,6	1,3
FBRJ030LGM	3,0	1/8	0,071	0,9	200	656	25	1,0	1,6	3,5
FBRJ032LGM	3,2	1/8	0,071	0,9	30,48	100	25	1,0	1,7	3,7
FBRJ040LGM	4,0	5/32	0,126	1,6	200	656	30	1,2	2,9	6,4
FBRJ048LGM	4,8	3/16	0,181	2,2	30,48	100	40	1,6	4,0	8,8
FBRJ050LGM	5,0	1/5	0,197	2,4	100	328	45	1,8	5,6	12,3
FBRJ060LGM	6,0	7/32	0,283	3,4	100	328	55	2,2	6,4	14,1
FBRJ063LGM	6,3	1/4	0,310	3,8	30,48	100	60	2,4	6,9	15,2
FBRJ070LGM	7,0	9/32	0,385	4,7	100	328	65	2,6	9,3	20,5
FBRJ079LGM	7,9	5/16	0,500	6,0	30,48	100	75	3,0	12,0	26,4
FBRJ080LGM	8,0	5/16	0,500	6,0	100	328	75	3,0	12,0	26,4
FBRJ095LGM	9,5	3/8	0,710	8,5	30,48	100	90	3,5	17,0	37,4
FBRJ100LGM	10,0	7/16	0,785	9,4	50	164	95	3,7	18,9	41,6
FBRJ120LGM	12,0	15/32	1,130	13,5	50	164	110	4,3	27,2	59,9
FBRJ125LGM	12,5	1/2	1,230	14,8	30,48	100	115	4,5	29,4	64,7
FBRJ143LGM	14,3	9/16	1,605	21,0	30,48	100	130	5,1	37,0	81,4
FBRJ150LGM	15,0	19/32	1,770	21,5	50	164	140	5,5	42,4	93,3

* = coefficient of friction $\mu:0,5$

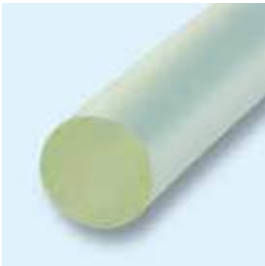

approx. 84° Shore A

Recommended pretension
4...8 %

Coefficient of friction μ

Steel	approx. 0,65
PE	approx. 0,35
HDPE	approx. 0,30

FDA/EC/USDA compliant

PU 80 A transparent smooth



Order No.	Diameter \varnothing		Cross Section cm ²	approx. Weight kg/100 m	Standard Roll		Recommended Min. pulley \varnothing		Fmax/belt (Standard)*	
	mm	inch			m	ft	mm	inch	kg	lbs
FBRP80A020TR	2,0	5/64	0,032	0,5	200	656	15	0,6	1,1	2,4
FBRP80A030TR	3,0	1/8	0,071	0,9	200	656	25	1,0	2,1	4,6
FBRP80A040TR	4,0	5/32	0,126	1,6	200	656	30	1,2	4,1	9,0
FBRP80A048TR	4,8	3/16	0,181	2,2	200	656	40	1,6	5,8	12,8
FBRP80A050TR	5,0	1/5	0,197	2,4	100	328	45	1,8	6,2	13,6
FBRP80A060TR	6,0	7/32	0,283	3,4	100	328	55	2,2	9,0	19,8
FBRP80A063TR	6,3	1/4	0,310	3,8	100	328	60	2,4	10,1	22,1
FBRP80A070TR	7,0	9/32	0,385	4,7	100	328	65	2,6	12,4	27,3
FBRP80A080TR	8,0	5/16	0,500	6,0	100	328	75	3,0	16,1	35,3
FBRP80A095TR	9,5	3/8	0,710	8,5	100	328	90	3,5	22,7	49,9
FBRP80A100TR	10,0	7/16	0,785	9,4	50	164	95	3,7	25,3	55,6
FBRP80A120TR	12,0	15/32	1,130	13,5	50	164	110	4,3	36,4	80,0
FBRP80A125TR	12,5	1/2	1,230	14,8	50	164	115	4,5	39,4	86,6
FBRP80A150TR	15,0	19/32	1,770	21,5	50	164	140	5,5	56,7	124,8
FBRP80A180TR	18,0	3/4	2,54	31,0	50	164	170	6,7	81,5	179,4
FBRP80A200TR	20,0	25/32	3,14	40,0	50	164	180	7,1	100,6	221,3

* = coefficient of friction $\mu:0,5$

Round belts | Shore 84, 88 A



PU 80 A orange smooth



Order No.	Diameter \varnothing		Cross Section cm ²	approx. Weight kg/100 m	Standard Roll		Recommended Min. pulley \varnothing		Fmax/belt (Standard)*	
	mm	inch			ft	(m)	mm	inch	kg	lbs
FBRP84A020	2,0	5/64	0,032	0,5	100	30,48	15	0,6	1,1	2,4
FBRP84A032	3,2	1/8	0,071	0,9	100	30,48	25	1,0	2,1	4,7
FBRP84A032A	3,2	1/8	0,071	0,9	500	152,4	25	1,0	2,2	4,9
FBRP84A040	4,0	5/32	0,126	1,6	100	30,48	30	1,2	4,1	8,9
FBRP84A048	4,8	3/16	0,181	2,2	100	30,48	40	1,6	5,8	12,7
FBRP84A048A	4,8	3/16	0,181	2,2	500	152,4	40	1,6	5,8	12,7
FBRP84A050	5,0	1/5	0,197	2,4	100	30,48	45	1,8	6,2	13,7
FBRP84A060	6,0	7/32	0,283	3,4	100	30,48	55	2,2	9,0	19,8
FBRP84A063	6,3	1/4	0,310	3,8	100	30,48	60	2,4	10,1	22,1
FBRP84A063A	6,3	1/4	0,310	3,8	500	152,4	60	2,4	10,1	22,1
FBRP84A070	7,0	9/32	0,385	4,7	100	30,48	65	2,6	12,4	27,3
FBRP84A079	7,9	5/16	0,500	6,0	100	30,48	75	3,0	16,1	35,3
FBRP84A079A	7,9	5/16	0,500	6,0	500	152,4	75	3,0	16,1	35,3
FBRP84A095	9,5	3/8	0,710	8,5	100	30,48	90	3,5	22,7	49,9
FBRP84A095	9,5	3/8	0,710	8,5	500	152,4	90	3,5	22,7	49,9
FBRP84A100	10,0	7/16	0,785	9,4	100	30,48	95	3,7	25,3	55,6
FBRP84A120	12,0	15/32	1,130	13,5	100	30,48	110	4,3	36,4	80,0
FBRP84A127	12,7	1/2	1,230	14,8	100	30,48	115	4,5	39,4	86,6
FBRP84A143	14,3	9/16	1,605	21,0	100	30,48	130	5,1	49,4	108,8
FBRP84A159	15,9	6/8	1,985	22,5	100	30,48	150	5,9	64,2	141,2
FBRP84A190	19,0	3/4	2,83	31,0	100	30,48	170	6,7	91,0	200,1

* = coefficient of friction μ :0,5

approx. 84° Shore A

Recommended pretension
4...8 %

Coefficient of friction μ

Steel approx. 0,65

PE approx. 0,35

HDPE approx. 0,30

FDA/EC/USDA compliant



PU 80 A orange smooth, reinforced polyester



Order No.	Diameter \varnothing		Cross Section cm ²	approx. Weight kg/100 m	Standard Roll		Recommended Min. pulley \varnothing		Fmax/belt (Standard)*		Fmax/belt (overlap)	
	mm	inch			ft	(m)	mm	inch	kg	lbs	kg	lbs
FBRJ0600GA	6,0	7/32	0,283	3,4	100	30,48	55	2,2	9,0	19,8	18,9	41,6
FBRJ0630GA	6,3	1/4	0,310	3,8	100	30,48	60	2,4	10,1	22,1	21,2	46,5
FBRJ0700GA	7,0	9/32	0,385	4,7	100	30,48	65	2,6	12,4	27,3	25,4	55,9
FBRJ0800GA	8,0	5/16	0,500	6,0	100	30,48	80	3,2	16,1	35,3	33,8	74,3
FBRJ0950GA	9,5	3/8	0,710	8,5	100	30,48	90	3,6	22,7	49,9	47,7	104,9
FBRJ1000GA	10,0	7/16	0,785	9,4	100	30,48	100	4	25,3	55,6	53,1	116,8
FBRJ1200GA	12,0	15/32	1,130	13,5	100	30,48	110	4,4	36,4	80,0	76,5	168,3
FBRJ1250GA	12,5	1/2	1,230	14,8	100	30,48	115	4,6	39,4	86,6	82,8	182,2
FBRJ1430GA	14,3	9/16	1,605	21,0	100	30,48	130	5,2	49,4	108,8	104,0	228,7
FBRJ1900GA	19,0	3/4	2,83	31,0	100	30,48	170	6,8	91,0	200,1	191,3	420,8
FBRJ2000GA	20,0	25/32	3,14	40,0	100	30,48	190	7,6	100,6	221,3	211,5	465,3

* = coefficient of friction μ :0,5

approx. 84° Shore A

Recommended pretension
0,5...2 %

Coefficient of friction μ

Steel approx. 0,65

PE approx. 0,35

HDPE approx. 0,30

FDA/EC/USDA compliant



PU 85 A sapphire blue smooth



approx. 88° Shore A

Recommended pretension
4...8 %

Coefficient of friction μ

Steel	approx. 0,60
PE	approx. 0,35
HDPE	approx. 0,30

FDA/EC/USDA compliant

Order No.	Diameter \varnothing		Cross Section cm ²	approx. Weight kg/100 m	Standard Roll		Recommended Min. pulley \varnothing		Fmax/belt (Standard)*	
	mm	inch			m	ft	mm	inch	kg	lbs
FBRK020LGAAA	2,0	5/64	0,032	0,5	200	656	15	0,6	1,0	2,2
FBRK030LGAAA	3,0	1/8	0,071	0,9	200	656	25	1	2,4	5,3
FBRK040LGAAA	4,0	5/32	0,126	1,6	200	656	35	1,4	4,2	9,3
FBRK048LGAAA	4,8	3/16	0,181	2,2	200	656	45	1,8	6,3	13,8
FBRK050LGAAA	5,0	1/5	0,197	2,4	100	328	50	2	6,7	14,7
FBRK060LGAAA	6,0	7/32	0,283	3,4	100	328	60	2,4	9,7	21,3
FBRK063LGAAA	6,3	1/4	0,310	3,8	100	328	65	2,6	10,7	23,6
FBRK070LGAAA	7,0	9/32	0,385	4,7	100	328	70	2,8	13,1	28,9
FBRK080LGAAA	8,0	5/16	0,500	6,0	100	328	80	3,2	17,2	37,8
FBRK095LGAAA	9,5	3/8	0,710	8,5	100	328	95	3,8	24,4	53,8
FBRK100LGAAA	10,0	7/16	0,785	9,4	50	164	100	4	26,9	59,1
FBRK120LGAAA	12,0	15/32	1,130	13,5	50	164	120	4,8	38,8	85,3
FBRK125LGAAA	12,5	1/2	1,230	14,8	50	164	125	5	42,2	92,9
FBRK150LGAAA	15,0	19/32	1,770	21,5	50	164	150	6	60,8	133,8

* = coefficient of friction $\mu:0,5$



PU 85 A green smooth

approx. 88° Shore A

Recommended pretension
4...8 %

Coefficient of friction μ

Steel	approx. 0,60
PE	approx. 0,35
HDPE	approx. 0,30

Order No.	Diameter \varnothing		Cross Section cm ²	approx. Weight kg/100 m	Standard Roll		Recommended Min. pulley \varnothing		Fmax/belt (Standard)*	
	mm	inch			m	ft	mm	inch	kg	lbs
FBRP85A020	2,0	5/64	0,032	0,5	200	656	15	0,6	1,2	2,7
FBRP85A030	3,0	1/8	0,071	0,9	200	656	25	1	2,7	5,8
FBRP85A040	4,0	5/32	0,126	1,6	200	656	35	1,4	4,7	10,3
FBRP85A048	4,8	3/16	0,181	2,2	200	656	45	1,8	6,7	14,8
FBRP85A050	5,0	1/5	0,197	2,4	100	328	50	2	7,1	15,7
FBRP85A060	6,0	7/32	0,283	3,4	100	328	60	2,4	10,4	22,9
FBRP85A063	6,3	1/4	0,310	3,8	100	328	65	2,6	11,4	25,1
FBRP85A070	7,0	9/32	0,385	4,7	100	328	70	2,8	14,1	31,0
FBRP85A080	8,0	5/16	0,500	6,0	100	328	80	3,2	18,4	40,4
FBRP85A095	9,5	3/8	0,710	8,5	100	328	95	3,8	25,9	57,0
FBRP85A100	10,0	7/16	0,785	9,4	50	164	100	4	28,6	62,8
FBRP85A120	12,0	15/32	1,130	13,5	50	164	120	4,8	40,8	89,8
FBRP85A125	12,5	1/2	1,230	14,8	50	164	125	5	44,9	98,7
FBRP85A15	15,0	19/32	1,770	21,5	50	164	150	6	64,9	142,7
FBRP85A18	18,0	3/4	2,54	31,0	50	164	180	7,2	92,8	204,2
FBRP85A20	20,0	25/32	3,14	40,0	50	164	220	8,8	115,3	253,6

* = coefficient of friction $\mu:0,5$

Round belts | Shore 88 A



PU 85 A green rough

Order No.	Diameter \varnothing		Cross Section cm ²	approx. Weight kg/100 m	Standard Roll		Recommended Min. pulley \varnothing		Fmax/belt (Standard)*	
	mm	inch			m	ft	mm	inch	kg	lbs
FBRP85A020R	2,0	5/64	0,032	0,5	200	656	15	0,6	1,2	2,7
FBRP85A030R	3,0	1/8	0,071	0,9	200	656	25	1	2,7	5,8
FBRP85A040R	4,0	5/32	0,126	1,6	200	656	35	1,4	4,7	10,3
FBRP85A048R	4,8	3/16	0,181	2,2	200	656	45	1,8	6,7	14,8
FBRP85A050R	5,0	1/5	0,197	2,4	100	328	50	2	7,1	15,7
FBRP85A060R	6,0	7/32	0,283	3,4	100	328	60	2,4	10,4	22,9
FBRP85A063R	6,3	1/4	0,310	3,8	100	328	65	2,6	11,4	25,1
FBRP85A070R	7,0	9/32	0,385	4,7	100	328	70	2,8	14,1	31,0
FBRP85A080R	8,0	5/16	0,500	6,0	100	328	80	3,2	18,4	40,4
FBRP85A095R	9,5	3/8	0,710	8,5	100	328	95	3,8	25,9	57,0
FBRP85A100R	10,0	7/16	0,785	9,4	50	164	100	4	28,6	62,8
FBRP85A120R	12,0	15/32	1,130	13,5	50	164	120	4,8	40,8	89,8
FBRP85A125R	12,5	1/2	1,230	14,8	50	164	125	5	44,9	98,7
FBRP85A15R	15,0	19/32	1,770	21,5	50	164	150	6	64,9	142,7
FBRP85A18R	18,0	3/4	2,54	31,0	50	164	180	7,2	92,8	204,2
FBRP85A20R	20,0	25/32	3,14	40,0	50	164	220	8,8	115,3	253,6

approx. 88° Shore A

Recommended pretension
4...8 %

Coefficient of friction μ

Steel approx. 0,45

PE approx. 0,30

HDPE approx. 0,25

* = coefficient of friction μ :0,5

antistatic



PU 85 A emerald green smooth, antistatic dissipative

Order No.	Diameter \varnothing		Cross Section cm ²	approx. Weight kg/100 m	Standard Roll		Recommended Min. pulley \varnothing		Fmax/belt (Standard)*	
	mm	inch			m	ft	mm	inch	kg	lbs
FBRK020GGAAA	2,0	5/64	0,032	0,5	200	656	15	0,6	1,2	2,7
FBRK030GGAAA	3,0	1/8	0,071	0,9	200	656	25	1	2,7	5,8
FBRK040GGAAA	4,0	5/32	0,126	1,6	200	656	35	1,4	4,7	10,3
FBRK048GGAAA	4,8	3/16	0,181	2,2	200	656	45	1,8	6,7	14,8
FBRK050GGAAA	5,0	1/5	0,197	2,4	100	328	50	2	7,1	15,7
FBRK060GGAAA	6,0	7/32	0,283	3,4	100	328	60	2,4	10,4	22,9
FBRK063GGAAA	6,3	1/4	0,310	3,8	100	328	65	2,6	11,4	25,1
FBRK070GGAAA	7,0	9/32	0,385	4,7	100	328	70	2,8	14,1	31,0
FBRK080GGAAA	8,0	5/16	0,500	6,0	100	328	80	3,2	18,4	40,4
FBRK095GGAAA	9,5	3/8	0,710	8,5	100	328	95	3,8	25,9	57,0
FBRK100GGAAA	10,0	7/16	0,785	9,4	50	164	100	4	28,6	62,8
FBRK120GGAAA	12,0	15/32	1,130	13,5	50	164	120	4,8	40,8	89,8
FBRK125GGAAA	12,5	1/2	1,230	14,8	50	164	125	5	44,9	98,7
FBRK150GGAAA	15,0	19/32	1,770	21,5	50	164	150	6	64,9	142,7

approx. 88° Shore A

Recommended pretension
4...8 %

Conductivity approx.
10⁹ Ω pro cm

ESD-suitable

Coefficient of friction μ

Steel approx. 0,60

PE approx. 0,35

HDPE approx. 0,30

* = coefficient of friction μ :0,5

Belts for electrostatic discharge. Conductive version on request

PATENT
LOW ELONGATION



approx. 88° Shore A

Recommended pretension
3...6 %

Coefficient of friction μ

Steel	approx. 0,45
PE	approx. 0,30
HDPE	approx. 0,25

PU 85 A PLUS blue rough

Order No.	Diameter \varnothing		Cross Section cm ²	approx. Weight kg/100 m	Standard Roll		Recommended Min. pulley \varnothing		Fmax/belt (Standard)*	
	mm	inch			m	ft	mm	inch	kg	lbs
FBRK020LR	2,0	5/64	0,032	0,5	200	656	15	0,6	1,3	2,9
FBRK030LR	3,0	1/8	0,071	0,9	200	656	25	1	3,0	6,6
FBRK040LR	4,0	5/32	0,126	1,6	200	656	35	1,4	5,3	11,6
FBRK048LR	4,8	3/16	0,181	2,2	200	656	45	1,8	7,5	16,5
FBRK050LR	5,0	1/5	0,197	2,4	100	328	50	2	8,1	17,8
FBRK060LR	6,0	7/32	0,283	3,4	100	328	60	2,4	11,7	25,6
FBRK063LR	6,3	1/4	0,310	3,8	100	328	65	2,6	12,8	28,1
FBRK070LR	7,0	9/32	0,385	4,7	100	328	70	2,8	16,0	35,2
FBRK080LR	8,0	5/16	0,500	6,0	100	328	80	3,2	20,7	45,5
FBRK095LR	9,5	3/8	0,710	8,5	100	328	95	3,8	29,3	64,5
FBRK100LR	10,0	7/16	0,785	9,4	50	164	100	4	32,5	71,6

* = coefficient of friction μ :0,5



approx. 88° Shore A

Recommended pretension:
welded 4...8 %
Fitting connector max. 3...6 %

PU 85 A yellow smooth/green rough hollow round belt

Order No.	YELLOW	GREEN	Diameter \varnothing		Cross Section cm ²	approx. Weight kg/100 m	Standard Roll		Recommended Min. pulley \varnothing		Fmax/belt (Standard)*	
			Outside	Inside			m	ft	mm	inch	kg	lbs
FBHP85A048	GE	R	4,8	1,8	0,147	1,8	200	656	35	1,4	5,3	11,7
FBHP85A063	GE	R	6,3	2,5	0,261	3,2	100	328	55	2,2	9,4	20,6
FBHP85A080	GE	R	8,0	3,2	0,420	5,1	100	328	65	2,6	15,3	33,7
FBHP85A095	GE	R	9,5	3,8	0,600	7,2	100	328	75	3,0	20,4	44,9
FBHP85A125	GE	R	12,5	5,2	1,020	12,4	50	164	100	3,9	36,7	80,8
FBHP85A150	GE	R	15,0	5,2	1,560	19,0	50	164	120	4,7	57,1	125,7

Coefficient of friction μ : Steel: approx. 0,45 (rough), approx. 0,60 (smooth) | PE: approx. 0,35 | HDPE: approx. 0,30

* = coefficient of friction μ :0,5



approx. 88° Shore A

Recommended pretension:
welded 4...8 %
Fitting connector max. 3...6 %

PU 85 A sapphire blue smooth hollow round belt



Order No.	Diameter \varnothing		Cross Section cm ²	approx. Weight kg/100 m	Standard Roll		Recommended Min. pulley \varnothing		Fmax/belt (Standard)*	
	Außen	inch			m	ft	mm	inch	kg	lbs
FBHK048LG	4,8	1,8	0,147	1,8	200	656	35	1,4	5,1	11,1
FBHK063LG	6,3	2,5	0,261	3,2	100	328	55	2,2	9,0	19,8
FBHK080LG	8,0	3,2	0,420	5,1	100	328	65	2,6	14,4	31,8
FBHK095LG	9,5	3,8	0,600	7,2	100	328	75	3,0	20,6	45,3
FBHK125LG	12,5	5,2	1,020	12,4	50	164	100	3,9	35,0	77,1
FBHK150LG	15,0	5,2	1,560	19,0	50	164	120	4,7	53,5	117,8

* = coefficient of friction μ :0,5

Coefficient of friction μ : Steel: approx. 0,60 | PE: approx. 0,35 | HDPE: approx. 0,30 | FDA/EC/USDA compliant

For suitable fitting connectors and info how to use them please refer to page 59.

Round belts | Shore 88 A



PU 85 A sapphire blue smooth, reinforced polyester



Order No.	Diameter Ø		Cross Section cm ²	approx. Weight kg/100 m	Standard Roll		Recommended Min. pulley Ø		Fmax/belt (Standard)*		Fmax/belt (overlap)	
	mm	inch			m	ft	mm	inch	kg	lbs	kg	lbs
FBRK060LGAAC	6,0	7/32	0,283	3,4	100	328	60	2,4	9,7	21,3	21,6	47,5
FBRK063LGA	6,3	1/4	0,310	3,8	100	328	65	2,6	10,7	23,6	23,9	52,5
FBRK070LGA	7,0	9/32	0,385	4,7	100	328	70	2,8	13,1	28,9	29,3	64,4
FBRK080LGA	8,0	5/16	0,500	6,0	100	328	80	3,2	17,2	37,8	38,3	84,2
FBRK095LGA	9,5	3/8	0,710	8,5	100	328	95	3,7	24,4	53,8	54,5	119,8
FBRK100LGA	10,0	7/16	0,785	9,4	50	164	100	3,9	26,9	59,1	59,9	131,7
FBRK120LGA	12,0	15/32	1,130	13,5	50	164	120	4,7	38,8	85,3	86,4	190,1
FBRK125LGA	12,5	1/2	1,230	14,8	50	164	125	4,9	42,2	92,9	94,1	206,9
FBRK150LGA	15,0	19/32	1,770	21,5	50	164	150	5,9	60,8	133,8	135,5	298,0

approx. 88° Shore A

Recommended pretension
0,5...2 %

Coefficient of friction μ : Steel: approx. 0,60 | PE: approx. 0,35 | HDPE: approx. 0,30 | FDA/EC/USDA compliant

* = coefficient of friction μ :0,5

PATENT
WELDABLE
reinforcement



PU 85 A ultramarine blue smooth, reinforced glass fiber PU

Order No.	Diameter Ø		Cross Section cm ²	approx. Weight kg/100 m	Standard Roll		Recommended Min. pulley Ø		Fmax/belt (Standard)*	
	mm	inch			m	ft	mm	inch	kg	lbs
FBZRP85A080	8,0	5/16	0,500	6,0	100	328	85	3,4	19,8	43,5
FBZRP85A095	9,5	3/8	0,71	8,5	100	328	100	4,0	28,1	61,9
FBZRP85A100	10,0	7/16	0,785	9,4	50	164	105	4,2	31,0	68,2
FBZRP85A120	12,0	15/32	1,130	13,5	50	164	125	5,0	44,7	98,3
FBZRP85A125	12,5	1/2	1,23	14,8	50	164	130	5,2	48,6	107,0
FBZRP85A143	14,3	9/16	1,605	21,0	50	164	150	6,0	63,4	139,4
FBZRP85A150	15,0	19/32	1,77	21,5	50	164	155	6,2	69,9	153,8

approx. 88° Shore A

Recommended pretension
0,5...2 %

Coefficient of friction μ : Steel: approx. 0,60 | PE: approx. 0,35 | HDPE: approx. 0,30

* = coefficient of friction μ :0,5

PATENT
WELDABLE
reinforcement



PU 85 A ultramarine blue rough, reinforced glass fiber PU

Order No.	Diameter Ø		Cross Section cm ²	approx. Weight kg/100 m	Standard Roll		Recommended Min. pulley Ø		Fmax/belt (Standard)*	
	mm	inch			m	ft	mm	inch	kg	lbs
FBZRP85A080R	8,0	5/16	0,500	6,0	100	328	85	3,2	19,8	43,5
FBZRP85A095R	9,5	3/8	0,710	8,5	100	328	100	3,7	28,1	61,9
FBZRP85A100R	10,0	7/16	0,785	9,4	50	164	105	3,9	31,0	68,2
FBZRP85A120R	12,0	15/32	1,130	13,5	50	164	125	4,7	44,7	98,3
FBZRP85A125R	12,5	1/2	1,230	14,8	50	164	130	4,9	48,6	107,0
FBZRP85A143R	14,3	9/16	1,605	21,0	50	164	150	5,7	63,4	139,4
FBZRP85A150R	15,0	19/32	1,770	21,5	50	164	155	5,9	69,9	153,8
FBZRP85A180R	18,0	3/4	2,54	31,0	50	164	195	7,5	-	-
FBZRP85A200R	20,0	25/32	3,14	40,0	50	164	205	7,9	-	-

approx. 88° Shore A

Recommended pretension
0,5...2 %

Coefficient of friction μ : Steel: approx. 0,45 | PE: approx. 0,35 | HDPE: approx. 0,30

* = coefficient of friction μ :0,5



PU 85 A green rough, reinforced aramid

Order No.	Diameter Ø		Cross Section cm ²	approx. Weight kg/100 m	Standard Roll		Recommended Min. pulley Ø		Fmax/belt (Standard)*		Fmax/belt (overlap)	
	mm	inch			m	ft	mm	inch	kg	lbs	kg	lbs
FBZR85A050RA	5,0	1/5	0,197	2,4	100	328	55	2,2	7,1	15,7	-	-
FBZR85A060RA	6,0	7/32	0,283	3,4	100	328	60	2,3	10,4	22,9	23,0	50,5
FBZR85A063RA	6,3	1/4	0,310	3,8	100	328	65	2,5	11,4	25,1	25,2	55,4
FBZR85A070RA	7,0	9/32	0,385	4,7	100	328	70	2,8	14,1	31,0	31,1	68,3
FBZR85A080RA	8,0	5/16	0,500	6,0	100	328	80	3,2	18,4	40,4	40,5	89,1
FBZR85A095RA	9,5	3/8	0,710	8,5	100	328	95	3,7	25,9	57,0	57,2	125,7
FBZR85A100RA	10,0	7/16	0,785	9,4	50	164	100	3,9	28,6	62,8	63,0	138,6
FBZR85A120RA	12,0	15/32	1,130	13,5	50	164	120	4,7	40,8	89,8	90,0	198,0
FBZR85A127RA	12,5	1/2	1,230	14,8	50	164	125	4,9	44,9	98,7	99,0	217,8
FBZR85A143RA	14,3	9/16	1,616	19,3	50	164	145	5,7	59,0	129,7	130,1	286,1
FBZR85A150RA	15,0	19/32	1,77	21,5	50	164	150	5,9	64,9	142,7	143,1	314,8
FBZR85A180RA	18,0	3/4	2,54	31,0	50	164	190	7,5	92,8	204,2	204,8	450,5
FBZR85A200RA	20,0	25/32	3,14	40,0	50	164	200	7,9	115,3	253,6	254,3	559,4

approx. 88° Shore A
Recommended pretension 0,5...2 %

Coefficient of friction μ	
Steel	approx. 0,45
PE	approx. 0,30
HDPE	approx. 0,25

* = coefficient of friction μ :0,5



PU 85 A green smooth, reinforced aramid

Order No.	Diameter Ø		Cross Section cm ²	approx. Weight kg/100 m	Standard Roll		Recommended Min. pulley Ø		Fmax/belt (Standard)*		Fmax/belt (overlap)	
	mm	inch			m	ft	mm	inch	kg	lbs	kg	lbs
FBZRP85A050A	5,0	1/5	0,197	2,4	100	328	55	2,2	7,1	15,7	-	-
FBZRP85A060A	6,0	7/32	0,283	3,4	100	328	60	2,3	10,4	22,9	23,0	50,5
FBZRP85A063A	6,3	1/4	0,310	3,8	100	328	65	2,5	11,4	25,1	25,2	55,4
FBZRP85A070A	7,0	9/32	0,385	4,7	100	328	70	2,8	14,1	31,0	31,1	68,3
FBZRP85A080A	8,0	5/16	0,500	6,0	100	328	80	3,2	18,4	40,4	40,5	89,1
FBZRP85A095A	9,5	3/8	0,710	8,5	100	328	95	3,7	25,9	57,0	57,2	125,7
FBZRP85A100A	10,0	7/16	0,785	9,4	50	164	100	3,9	28,6	62,8	63,0	138,6
FBZRP85A120A	12,0	15/32	1,130	13,5	50	164	120	4,7	40,8	89,8	90,0	198,0
FBZRP85A125A	12,5	1/2	1,230	14,8	50	164	125	4,9	44,9	98,7	99,0	217,8
FBZRP85A143A	14,3	9/16	1,616	19,3	50	164	145	5,7	59,0	129,7	130,1	286,1
FBZRP85A150A	15,0	19/32	1,77	21,5	50	164	150	5,9	64,9	142,7	143,1	314,8
FBZRP85A180A	18,0	3/4	2,54	31,0	50	164	190	7,5	92,8	204,2	204,8	450,5
FBZRP85A200A	20,0	25/32	3,14	40,0	50	164	200	7,9	115,3	253,6	254,3	559,4



FBZR85A095SA FBZR85A095HA

more information on page 49

approx. 88° Shore A
Recommended pretension 0,5...2 %

Coefficient of friction μ : Steel: approx. 0,60 | PE: approx. 0,35 | HDPE: approx. 0,30

* = coefficient of friction μ :0,5

Round belts | Shore 92 A



PU 90 A white smooth

Order No.	Diameter \varnothing		Cross Section cm ²	approx. Weight kg/100 m	Standard Roll		Recommended Min. pulley \varnothing		Fmax/belt (Standard)*	
	mm	inch			m	ft	mm	inch	kg	lbs
FBRP90A020	2,0	5/64	0,032	0,5	200	656	20	0,8	1,9	4,1
FBRP90A030	3,0	1/8	0,071	0,9	200	656	30	1,2	3,4	7,4
FBRP90A040	4,0	5/32	0,126	1,6	200	656	40	1,6	5,9	12,9
FBRP90A048	4,8	3/16	0,181	2,2	200	656	50	2	8,5	18,7
FBRP90A050	5,0	1/5	0,197	2,4	100	328	55	2,2	9,3	20,4
FBRP90A060	6,0	7/32	0,283	3,4	100	328	65	2,6	13,3	29,2
FBRP90A063	6,3	1/4	0,310	3,8	100	328	70	2,8	14,6	32,2
FBRP90A070	7,0	9/32	0,385	4,7	100	328	75	3	18,3	40,2
FBRP90A080	8,0	5/16	0,500	6,0	100	328	85	3,4	23,8	52,3
FBRP90A095	9,5	3/8	0,710	8,5	100	328	95	3,8	33,3	73,2
FBRP90A100	10,0	7/16	0,785	9,4	50	164	105	4,2	37,3	82,0
FBRP90A120	12,0	15/32	1,130	13,5	50	164	120	4,8	53,3	117,2
FBRP90A125	12,5	1/2	1,23	14,8	50	164	125	5	58,0	127,6
FBRP90A15	15,0	19/32	1,770	21,5	50	164	150	6	83,6	184,0
FBRP90A18	18,0	3/4	2,54	31,0	50	164	185	7,4	119,8	263,5
FBRP90A20	20,0	25/32	3,14	40,0	50	164	200	8	148,3	326,2

* = coefficient of friction μ :0,5

Red on request

approx. 92° Shore A

Recommended pretension
3...5 %

Coefficient of friction μ

Steel	approx. 0,50
PE	approx. 0,30
HDPE	approx. 0,25



PU 90 A white smooth hollow round belt



Order No.	Diameter \varnothing		Cross Section cm ²	approx. Weight kg/100 m	Standard Roll		Recommended Min. pulley \varnothing		Fmax/belt (Standard)*	
	Outside	Inside			m	ft	mm	inch	kg	lbs
FBHP90A048	4,8	1,8	0,147	1,8	200	656	45	1,8	8,6	19,0
FBHP90A063	6,3	2,5	0,261	3,2	100	328	60	2,4	12,4	27,2
FBHP90A080	8,0	3,2	0,420	5,1	100	328	75	3,0	19,0	41,8
FBHP90A095	9,5	3,8	0,600	7,2	100	328	85	3,4	28,5	62,7
FBHP90A125	12,5	5,2	1,020	12,4	50	164	115	4,5	47,5	104,5
FBHP90A150	15,0	5,2	1,560	19,0	50	164	140	5,5	72,3	159,0

* = coefficient of friction μ :0,5

approx. 92° Shore A

Recommended pretension:
welded 3...5 %
Fitting connector max. 2...4 %

Coefficient of friction μ : Steel: approx. 0,50 | PE: approx. 0,30 | HDPE: approx. 0,25

For suitable fitting connectors and info how to use them please refer to page 59



PU 90 A white smooth, reinforced polyester

Order No.	Diameter Ø		Cross Section cm ²	approx. Weight kg/100 m	Standard Roll		Recommended Min. pulley Ø		Fmax/belt (Standard)*		Fmax/belt (overlap)	
	mm	inch			m	ft	mm	inch	kg	lbs	kg	lbs
FBZRP90A060P	6,0	7/32	0,283	3,4	100	328	70	2,8	13,4	29,6	22,5	49,5
FBZRP90A063P	6,3	1/4	0,310	3,8	100	328	75	3	14,8	32,5	26,3	57,8
FBZRP90A070P	7,0	9/32	0,385	4,7	100	328	80	3,2	18,4	40,6	37,5	82,5
FBZRP90A080P	8,0	5/16	0,500	6,0	100	328	90	3,6	24,0	52,8	48,8	107,3
FBZRP90A095P	9,5	3/8	0,710	8,5	100	328	105	4,2	33,6	73,9	56,3	123,8
FBZRP90A100P	10,0	7/16	0,785	9,4	50	164	110	4,4	37,6	82,8	60,0	132,0
FBZRP90A120P	12,0	15/32	1,130	13,5	50	164	125	5	53,8	118,3	101,3	222,8
FBZRP90A125P	12,5	1/2	1,230	14,8	50	164	130	5,2	58,6	128,8	108,8	239,3
FBZRP90A150P	15,0	19/32	1,770	21,5	50	164	155	6,2	84,5	185,9	172,5	379,5
FBZRP90A180P	18,0	3/4	2,54	31,0	50	164	190	7,6	121,0	266,1	225,0	495,0
FBZRP90A200P	20,0	25/32	3,14	40,0	50	164	210	8,4	-	-	-	-

approx. 92° Shore A

Recommended pretension
0,5...2 %

Coefficient of friction μ

Steel	approx. 0,50
PE	approx. 0,30
HDPE	approx. 0,25

* = coefficient of friction μ:0.5



Polyester TPE 40 D beige smooth



Order No.	Diameter Ø		Cross Section cm ²	approx. Weight kg/100 m	Standard Roll		Recommended Min. pulley Ø		Fmax/belt (Standard)*	
	mm	inch			m	ft	mm	inch	kg	lbs
FBRKO40D020	2,0	5/64	0,032	0,5	200	656	20	0,8	1,9	4,2
FBRKO40D030	3,0	1/8	0,071	0,9	200	656	30	1,2	4,1	9,1
FBRKO40D040	4,0	5/32	0,126	1,6	200	656	40	1,6	7,6	16,6
FBRKO40D048	4,8	3/16	0,181	2,2	200	656	50	2	10,8	23,8
FBRKO40D050	5,0	1/5	0,197	2,4	100	328	55	2,2	11,7	25,7
FBRKO40D060	6,0	7/32	0,283	3,4	100	328	65	2,6	17,0	37,5
FBRKO40D063	6,3	1/4	0,310	3,8	100	328	70	2,8	18,7	41,2
FBRKO40D070	7,0	9/32	0,385	4,7	100	328	75	3	23,0	50,7
FBRKO40D080	8,0	5/16	0,500	6,0	100	328	85	3,4	30,1	66,2
FBRKO40D095	9,5	3/8	0,710	8,5	100	328	95	3,8	42,8	94,2
FBRKO40D100	10,0	7/16	0,785	9,4	50	164	105	4,2	47,1	103,7
FBRKO40D120	12,0	15/32	1,130	13,5	50	164	120	4,8	67,9	149,5
FBRKO40D125	12,5	1/2	1,230	14,8	50	164	125	5	74,0	162,7
FBRKO40D150	15,0	19/32	1,770	21,5	50	164	150	6	106,5	234,2
FBRKO40D180	18,0	3/4	2,54	31,0	50	164	185	7,4	151,4	333,0
FBRKO40D200	20,0	25/32	3,14	40,0	50	164	200	8	188,2	414,0

approx. 40° Shore D / 95° Shore A

Recommended pretension
2...4 %

Coefficient of friction μ

Steel	approx. 0,50
PE	approx. 0,30
HDPE	approx. 0,25

FDA/EC/USDA compliant

* = coefficient of friction μ:0.5

Polyester TPE 40D beige smooth reinforced on request

Round belts | Shore 55 D



Polyester TPE 55 D beige smooth



Order No.	Diameter Ø		Cross Section cm ²	approx. Weight kg/100 m	Standard Roll		Recommended Min. pulley Ø		Fmax/belt (Standard)*	
	mm	inch			m	ft	mm	inch	kg	lbs
FBRH55D020B	2,0	5/64	0,032	0,5	200	656	30	1,2	2,4	5,3
FBRH55D030B	3,0	1/8	0,071	0,9	200	656	35	1,4	5,6	12,3
FBRH55D040B	4,0	5/32	0,126	1,6	200	656	50	2	9,9	21,8
FBRH55D048B	4,8	3/16	0,181	2,2	200	656	60	2,4	14,4	31,7
FBRH55D050B	5,0	1/5	0,197	2,4	100	328	65	2,6	15,7	34,5
FBRH55D060B	6,0	7/32	0,283	3,4	100	328	75	3	22,4	49,3
FBRH55D063B	6,3	1/4	0,310	3,8	100	328	80	3,2	24,8	54,6
FBRH55D070B	7,0	9/32	0,385	4,7	100	328	90	3,6	30,4	66,9
FBRH55D080B	8,0	5/16	0,500	6,0	100	328	100	4	40,0	88,0
FBRH55D095B	9,5	3/8	0,710	8,5	100	328	120	4,8	56,0	123,2
FBRH55D100B	10,0	7/16	0,785	9,4	50	164	125	5	62,9	138,3
FBRH55D120B	12,0	15/32	1,130	13,5	50	164	150	6	90,6	199,2
FBRH55D125B	12,5	1/2	1,230	14,8	50	164	160	6,4	97,6	214,7
FBRH55D150B	15,0	19/32	1,770	21,5	50	164	180	7,2	140,8	309,8
FBRH55D180B	18,0	3/4	2,54	31,0	50	164	240	9,6	203,2	447,0
FBRH55D200B	20,0	25/32	3,14	40,0	50	164	300	12	251,2	552,6

approx. 55° Shore D / 100° Shore A
Recommended pretension
2...4 %

Coefficient of friction μ	
Steel	approx. 0,35
PE	approx. 0,20
HDPE	approx. 0,15
FDA/EC/USDA compliant	

* = coefficient of friction $\mu:0,5$

Further colours on request



Polyester TPE 55 D beige smooth, reinforced polyester



Order No.	Diameter Ø		Cross Section cm ²	approx. Weight kg/100 m	Standard Roll		Recommended Min. pulley Ø		Fmax/belt (Standard)*		Fmax/belt (overlap)	
	mm	inch			m	ft	mm	inch	kg	lbs	kg	lbs
FBZRH55D060B	6,0	7/32	0,283	3,4	100	328	75	3,0	22,4	49,3	45,0	99,0
FBZRH55D063B	6,3	1/4	0,310	3,8	100	328	80	3,2	24,8	54,6	48,8	107,3
FBZRH55D070B	7,0	9/32	0,385	4,7	100	328	90	3,5	30,4	66,9	60,0	132,0
FBZRH55D080B	8,0	5/16	0,500	6,0	100	328	100	3,9	40,0	88,0	71,3	156,8
FBZRH55D095B	9,5	3/8	0,771	8,5	100	328	120	4,7	56,0	123,2	90,0	198,0
FBZRH55D100B	10,0	7/16	0,785	9,4	50	164	125	4,9	62,9	138,3	97,5	214,5
FBZRH55D120B	12,0	15/32	1,130	13,5	50	164	150	5,9	90,6	199,2	127,5	280,5
FBZRH55D125B	12,5	1/2	1,230	14,8	50	164	160	6,3	97,6	214,7	135,0	297,0
FBZRH55D150B	15,0	19/32	1,770	21,5	50	164	180	7,1	140,8	309,8	206,3	453,8
FBZRH55D180B	18,0	3/4	2,54	31,0	50	164	240	9,5	203,2	447,0	243,8	536,3
FBZRH55D200B	20,0	25/32	3,14	40,0	50	164	300	11,8	-	-	-	-

approx. 55° Shore D / 100° Shore A
Recommended pretension
0,5...2 %

Coefficient of friction μ	
Steel	approx. 0,35
PE	approx. 0,20
HDPE	approx. 0,15
FDA/EC/USDA compliant	

* = coefficient of friction $\mu:0,5$



55° Shore D · approx. 100° Shore A
Recommended pretension
max. 0,5 %

Polyester TPE 55 D beige smooth, reinforced steel



Order No.	Diameter Ø		Cross Section cm ²	approx. Weight kg/100 m	Standard Roll		Recommended Min. pulley Ø		Fmax/belt (Standard)* ★	
	mm	inch			m	ft	mm	inch	kg	lbs
FBRS095BGB	9,5	3/8	0,710	8,5	500	1640	380	15,0	150	330
FBRS100BGB	10,0	7/16	0,785	9,4	500	1640	380	15,0	150	330
FBRS120BGB	12,0	15/32	1,082	13,0	500	1640	380	15,0	150	330
FBRS125BGB	12,5	1/2	1,230	14,8	500	1640	380	15,0	150	330

Coefficient of friction μ : Steel: approx. 0,35 | PE: approx. 0,20 | HDPE: approx. 0,15 | FDA/EC/USDA compliant

★ for joining system with crimps please refer to page 91

* = coefficient of friction μ :0,5



63° Shore D · approx. >100° Shore A
Recommended pretension
0,5...2 %

Polyester TPE 63 D silver smooth, reinforced polyester



Order No.	Diameter Ø		Cross Section cm ²	approx. Weight kg/100 m	Standard Roll		Recommended Min. pulley Ø		Fmax/belt (Standard)*		Fmax/belt (overlap)	
	mm	inch			ft	(m)	mm	inch	kg	lbs	kg	lbs
FBRT063IGA	6,3	1/4	0,310	3,8	500	152,4	100	3,9	25,9	57,0	51,0	112,2
FBRT095IGA	9,5	3/8	0,710	8,5	500	152,4	150	5,9	59,4	130,6	105,0	231,0
FBRT125IGA	12,5	1/2	1,230	14,8	500	152,4	200	7,8	102,8	226,2	150,0	330,0

Coefficient of friction μ : Steel: approx. 0,30 | PE: approx. 0,15 | HDPE: approx. 0,10 | FDA/EC/USDA compliant

* = coefficient of friction μ :0,5



63° Shore D · approx. >100° Shore A
Recommended pretension
0,5...2 %

Polyester TPE 63 D beige smooth, reinforced polyester



Order No.	Diameter Ø		Cross Section cm ²	approx. Weight kg/100 m	Standard Roll		Recommended Min. pulley Ø		Fmax/belt (Standard)*		Fmax/belt (overlap)	
	mm	inch			ft	(m)	mm	inch	kg	lbs	kg	lbs
FBRT063NGA	6,3	1/4	0,310	3,8	500	152,4	100	3,9	25,9	57,0	51,0	112,2
FBRT095NGB	9,5	3/8	0,710	8,5	350	106,68	150	5,9	59,4	130,6	105,0	231,0
FBRT095NGA	9,5	3/8	0,710	8,5	500	152,4	150	5,9	59,4	130,6	105,0	231,0
FBRT125NGA	12,5	1/2	1,230	14,8	500	152,4	200	7,8	102,8	226,2	150,0	330,0

Coefficient of friction μ : Steel: approx. 0,30 | PE: approx. 0,15 | HDPE: approx. 0,10 | FDA/EC/USDA compliant

* = coefficient of friction μ :0,5



63° Shore D · approx. >100° Shore A
Recommended pretension
0,5...2 %

Polyester TPE 63 D beige smooth, reinforced aramid



Order No.	Diameter Ø		Cross Section cm ²	approx. Weight kg/100 m	Standard Roll		Recommended Min. pulley Ø		Fmax/belt (Standard)*		Fmax/belt (overlap)	
	mm	inch			ft	(m)	mm	inch	kg	lbs	kg	lbs
FBRT063NGC	6,3	1/4	0,310	3,8	500	152,4	100	3,9	25,9	57,0	51,0	112,2
FBRT095NGC	9,5	3/8	0,710	8,5	500	152,4	150	5,9	59,4	130,6	105,0	231,0
FBRT125NGC	12,5	1/2	1,230	14,8	500	152,4	200	7,8	102,8	226,2	150,0	330,0

Coefficient of friction μ : Steel: approx. 0,30 | PE: approx. 0,15 | HDPE: approx. 0,10 | FDA/EC/USDA compliant

* = coefficient of friction μ :0,5

U-belts / Shore 80 A



PU 75 A sky blue smooth

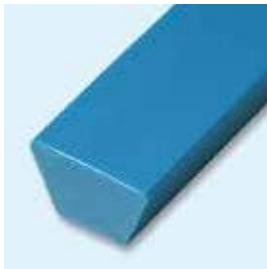

approx. 80° Shore A

Recommended pretension
4...8 %

Order No.	Profile dimension mm	Cross Section cm ²	approx. Weight kg/100 m	Standard Roll		Recommended Min. pulley ∅		Fmax/belt (Standard)*	
				m	ft	mm	inch	kg	lbs
FBKI6YLGA	6 x 4 (Y)	0,19	2,3	100	328	35	1,4	4,6	10,1
FBKI8MLGA	8 x 5 (M)	0,32	4,0	100	328	40	1,6	7,6	15,8
FBKI10ZLGA	10 x 6 (Z)	0,48	6,0	50	164	50	2,0	11,6	25,5
FBKI13ALGA	13 x 8 (A)	0,82	10,0	50	164	80	3,2	19,6	43,1
FBKI17BLGA	17 x 11 (B)	1,46	18,0	50	164	100	3,9	35,0	77,0

Coefficient of friction μ : Steel: approx. 0,70 | PE: approx. 0,40 | HDPE: approx. 0,35 | FDA/EC/USDA compliant

* = coefficient of friction μ :0,5

PU 75 A red smooth



approx. 80° Shore A

Recommended pretension
4...8 %

Order No.	Profile dimension mm	Cross Section cm ²	approx. Weight kg/100 m	Standard Roll		Recommended Min. pulley ∅		Fmax/belt (Standard)*	
				m	ft	mm	inch	kg	lbs
FBKP75A06	6 x 4 (Y)	0,19	2,3	100	328	35	1,4	4,9	10,8
FBKP75A08	8 x 5 (M)	0,32	4,0	100	328	40	1,6	8,2	18,1
FBKP75A10	10 x 6 (Z)	0,48	6,0	50	164	50	2,0	12,2	26,7
FBKP75A13	13 x 8 (A)	0,82	10,0	50	164	80	3,2	20,6	45,3
FBKP75A17	17 x 11 (B)	1,46	18,0	50	164	100	3,9	37,2	81,9
FBKP75A22	22 x 14 (C)	2,40	29,0	50	164	145	5,7	60,8	133,7
FBKP75A32	32 x 20 (D)	5,00	62,0	25	82	210	8,3	127,4	280,3

Coefficient of friction μ : Steel: approx. 0,70 | PE: approx. 0,40 | HDPE: approx. 0,35

* = coefficient of friction μ :0,5

PATENT
WELDABLE
reinforcement



approx. 80° Shore A

Recommended pretension
0,5...2 %

PU 75 A orange, reinforced glass fiber

Order No.	Profile dimension mm	Cross Section cm ²	approx. Weight kg/100 m	Standard Roll		Recommended Min. pulley ∅		Fmax/belt (Standard)*	
				m	ft	mm	inch	kg	lbs
FBZKP75A13GL	13 x 8 (A)	0,82	10,0	50	164	110	4,4	25,3	55,6
FBZKP75A17GL	17 x 11 (B)	1,46	18,0	50	164	140	5,5	45,0	98,9
FBZKP75A22GL	22 x 14 (C)	2,40	29,0	50	164	180	7,1	66,2	145,7

Coefficient of friction μ : Steel: approx. 0,70 | PE: approx. 0,40 | HDPE: approx. 0,35

* = coefficient of friction μ :0,5

PU 75 A light grey, reinforced polyester



approx. 80° Shore A

Recommended pretension
0,5...2 %

Order No.	Profile dimension mm	Cross Section cm ²	approx. Weight kg/100 m	Standard Roll		Recommended Min. pulley ∅		Fmax/belt (Standard)*		Fmax/belt (overlap)	
				m	ft	mm	inch	kg	lbs	kg	lbs
FBKI17BHGA	17 x 11 (B)	1,46	18,0	50	164	120	4,7	37,2	81,9	83,8	184,4
FBKI22CHGA	22 x 14 (C)	2,40	29,0	50	164	160	6,3	60,8	133,7	127,5	280,5

Coefficient of friction μ : Steel: approx. 0,70 | PE: approx. 0,40 | HDPE: approx. 0,35

* = coefficient of friction μ :0,5

SAFE

Metal detectable



approx. 84° Shore A

Recommended pretension
3...6 %

PU 80 A SAFE capri blue smooth



Order No.	Profile dimension mm	Cross Section cm ²	approx. Weight kg/100 m	Standard Roll		Recommended Min. pulley Ø		Fmax/belt (Standard)*	
				m	ft	mm	inch	kg	lbs
FBKJ6YLGGM	6 x 4 (Y)	0,19	2,3	100	328	40	1,6	4,6	10,2
FBKJ8MLGGM	8 x 5 (M)	0,32	4,0	100	328	45	1,8	7,7	16,9
FBKJ10ZLGM	10 x 6 (Z)	0,48	6,0	50	164	55	2,2	11,5	25,3
FBKJ13ALGM	13 x 8 (A)	0,82	10,0	50	164	85	3,3	19,7	43,3
FBKJ17BLGM	17 x 11 (B)	1,46	18,0	50	164	110	4,3	35,0	77,1
FBKJ22CLGM	22 x 14 (C)	2,40	29,0	50	164	150	6,0	57,6	126,7

Coefficient of friction μ : Steel: approx. 0,65 | PE: approx. 0,35 | HDPE: approx. 0,30 | FDA/EC/USDA compliant

* = coefficient of friction μ :0,5



approx. 84° Shore A

Recommended pretension
4...8 %

PU 80 A transparent smooth



Order No.	Profile dimension mm	Cross Section cm ²	approx. Weight kg/100 m	Standard Roll		Recommended Min. pulley Ø		Fmax/belt (Standard)*	
				m	ft	mm	inch	kg	lbs
FBKP80A06TR	6 x 4 (Y)	0,19	2,3	100	328	40	1,6	6,2	13,7
FBKP80A08TR	8 x 5 (M)	0,32	4,0	100	328	45	1,8	10,3	22,6
FBKP80A10TR	10 x 6 (Z)	0,48	6,0	50	164	55	2,2	15,4	33,9
FBKP80A13TR	13 x 8 (A)	0,82	10,0	50	164	85	3,3	26,3	57,9
FBKP80A17TR	17 x 11 (B)	1,46	18,0	50	164	110	4,3	46,9	103,1
FBKP80A22TR	22 x 14 (C)	2,40	29,0	50	164	150	5,9	77,0	169,5
FBKP80A32TR	32 x 20 (D)	5,00	62,0	25	82	220	8,7	160,5	353,1

Coefficient of friction μ : Steel: approx. 0,65 | PE: approx. 0,35 | HDPE: approx. 0,30 | FDA/EC/USDA compliant

* = coefficient of friction μ :0,5



approx. 84° Shore A

Recommended pretension
4...8 %

PU 80 A orange smooth



Order No.	Profile dimension mm	Cross Section cm ²	approx. Weight kg/100 m	Standard Roll		Recommended Min. pulley Ø		Fmax/belt (Standard)*	
				ft	(m)	mm	inch	kg	lbs
FBJ6YOG	6 x 4 (Y)	0,19	2,3	100	30,48	40	1,6	6,2	13,7
FBJ8MOG	8 x 5 (M)	0,32	4,0	100	30,48	45	1,8	10,3	22,6
FBJ10ZOG	10 x 6 (Z)	0,48	6,0	100	30,48	55	2,2	15,4	33,9
FBJ13AOG	13 x 8 (A)	0,82	10,0	100	30,48	85	3,3	26,3	57,9
FBJ17BOG	17 x 11 (B)	1,46	18,0	100	30,48	110	4,3	46,9	103,1
FBJ22COG	22 x 14 (C)	2,40	29,0	100	30,48	150	5,9	77,0	169,5
FBJ32DOG	32 x 20 (D)	5,00	62,0	100	30,48	220	8,7	160,5	353,1

Coefficient of friction μ : Steel: approx. 0,65 | PE: approx. 0,35 | HDPE: approx. 0,30 | FDA/EC/USDA compliant

* = coefficient of friction μ :0,5

V-belts / Shore 84, 88 A



PU 80 A orange smooth, reinforced polyester



Order No.	Profile dimension mm	Cross Section cm ²	approx. Weight kg/100 m	Standard Roll		Recommended Min. pulley ∅		Fmax/belt (Standard)*		Fmax/belt (overlap)	
				ft	m	mm	inch	kg	lbs	kg	lbs
FBJ8MOGA	8 x 5 (M)	0,32	4,0	100	(30,48)	50	2,0	10,3	22,6	21,6	47,5
FBJ10ZOGA	10 x 6 (Z)	0,48	6,0	100	(30,48)	60	2,4	15,4	33,9	32,4	71,3
FBJ13AOGA	13 x 8 (A)	0,82	10,0	100	(30,48)	90	3,5	25,9	57,0	54,5	119,8
FBJ13AOGA001	13 x 8 (A)	0,82	10,0	(164)	50	90	3,5	25,9	57,0	54,5	119,8
FBJ17BOGA	17 x 11 (B)	1,46	18,0	100	(30,48)	120	4,7	46,9	103,1	98,6	216,8
FBJ17BOGC	17 x 11 (B)	1,46	18,0	(328)	100	120	4,7	46,9	103,1	98,6	216,8
FBJ22COGA	22 x 14 (C)	2,40	29,0	100	(30,48)	160	6,3	77,0	169,5	150,0	330,0

approx. 84° Shore A

Recommended pretension
0,5...2 %

Coefficient of friction μ : Steel: approx. 0,65 | PE: approx. 0,35 | HDPE: approx. 0,30 | FDA/EC/USDA compliant

* = coefficient of friction μ :0,5

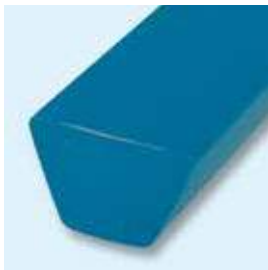

PU 85 A sapphire blue smooth



Order No.	Profile dimension mm	Cross Section cm ²	approx. Weight kg/100 m	Standard Roll		Recommended Min. pulley ∅		Fmax/belt (Standard)*	
				m	ft	mm	inch	kg	lbs
FBKK06MLGAAA	6 x 4 (Y)	0,19	2,3	100	328	45	1,8	6,5	14,2
FBKK08MLGAAA	8 x 5 (M)	0,32	4,0	100	328	50	2,0	10,9	24,0
FBKK10ZLGAAA	10 x 6 (Z)	0,48	6,0	50	164	65	2,6	16,6	36,4
FBKK13ALGAAA	13 x 8 (A)	0,82	10,0	50	164	95	3,8	28,1	61,8
FBKK17BLGAAA	17 x 11 (B)	1,46	18,0	50	164	120	4,7	50,1	110,2
FBKK22CLGAAA	22 x 14 (C)	2,40	29,0	50	164	160	6,3	82,4	181,3

approx. 88° Shore A

Recommended pretension
4...8 %

Coefficient of friction μ : Steel: approx. 0,60 | PE: approx. 0,35 | HDPE: approx. 0,30 | FDA/EC/USDA compliant

* = coefficient of friction μ :0,5

V-belts with reinforcement available on request



PU 85 A green smooth

Order No.	Profile dimension mm	Cross Section cm ²	approx. Weight kg/100 m	Standard Roll		Recommended Min. pulley ∅		Fmax/belt (Standard)*	
				m	ft	mm	inch	kg	lbs
FBKP85A06	6 x 4 (Y)	0,19	2,3	100	328	45	1,8	6,9	15,3
FBKP85A08	8 x 5 (M)	0,32	4,0	100	328	50	2,0	11,6	25,6
FBKP85A10	10 x 6 (Z)	0,48	6,0	50	164	65	2,6	17,5	38,6
FBKP85A13	13 x 8 (A)	0,82	10,0	50	164	95	3,8	30,0	66,0
FBKP85A17	17 x 11 (B)	1,46	18,0	50	164	120	4,7	53,0	116,7
FBKP85A22	22 x 14 (C)	2,40	29,0	50	164	160	6,3	87,7	193,0
FBKP85A32	32 x 20 (D)	5,00	62,0	25	82	230	9,1	195,8	430,8

approx. 88° Shore A

Recommended pretension
4...8 %

Coefficient of friction μ : Steel: approx. 0,60 | PE: approx. 0,35 | HDPE: approx. 0,30

* = coefficient of friction μ :0,5

PATENT
LOW ELONGATION



approx. 88° Shore A

Recommended pretension
3...6 %

PU 85 A PLUS blue matt finish

Order No.	Profile dimension mm	Cross Section cm ²	approx. Weight kg/100 m	Standard Roll		Recommended Min. pulley Ø		Fmax/belt (Standard)*	
				m	ft	mm	inch	kg	lbs
FBKP85A06BP	6 x 4 (Y)	0,19	2,3	100	328	45	1,8	7,9	17,4
FBKP85A08BP	8 x 5 (M)	0,32	4,0	100	328	50	2,0	13,2	29,0
FBKP85A10BP	10 x 6 (Z)	0,48	6,0	50	164	65	2,6	19,9	43,8
FBKP85A13BP	13 x 8 (A)	0,82	10,0	50	164	95	3,8	33,8	74,4
FBKP85A17BP	17 x 11 (B)	1,46	18,0	50	164	120	4,7	60,3	132,8
FBKP85A22BP	22 x 14 (C)	2,40	29,0	50	164	160	6,3	99,3	218,4
FBKP85A32BP	32 x 20 (D)	5,00	62,0	25	82	230	9,1	206,8	455,0

Coefficient of friction μ : Steel: approx. 0,60 | PE: approx. 0,35 | HDPE: approx. 0,30

* = coefficient of friction μ :0,5

PATENT
LOW ELONGATION



approx. 88° Shore A

Recommended pretension
3...6 %

PU 85 A PLUS, PJ2/PJ3, V-ribbed belt, ultramarine blue

Order No.	Description	Profile dimension mm	Cross Section cm ²	approx. Weight kg/100 m	Standard Roll		Recommended Min. pulley Ø		Fmax/belt (Standard)*	
					m	ft	mm	inch	kg	lbs
FBPVKJ2L	PJ2	4,8 x 4	0,16	1,96	200	656	40	1,6	10,3	22,7
FBPVKJ3L	PJ3	7 x 4	0,24	2,93	200	656	40	1,6	15,0	33,1

Coefficient of friction μ : Steel: approx. 0,60 | PE: approx. 0,35 | HDPE: approx. 0,30

* = coefficient of friction μ :0,5

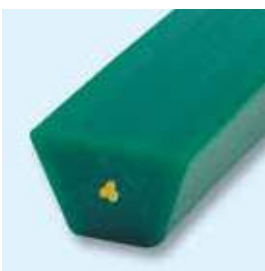

approx. 88° Shore A

Recommended pretension
0,5...2 %

PU 85 A green, reinforced aramid

Order No.	Profile dimension mm	Cross Section cm ²	approx. Weight kg/100 m	Standard Roll		Recommended Min. pulley Ø		Fmax/belt (Standard)*		Fmax/belt (overlap)	
				m	ft	mm	inch	kg	lbs	kg	lbs
FBZKP85A08A	8 x 5 (M)	0,32	4,0	100	328	60	2,4	11,6	25,6	25,7	56,4
FBZKP85A10A	10 x 6 (Z)	0,48	6,0	50	164	70	2,8	17,5	38,6	37,5	82,5
FBZKP85A13A	13 x 8 (A)	0,82	10,0	50	164	100	3,9	30,0	66,0	63,8	140,3
FBZKP85A17A	17 x 11 (B)	1,46	18,0	50	164	140	5,5	53,0	116,7	112,5	247,5
FBZKP85A22A	22 x 14 (C)	2,40	29,0	50	164	180	7,1	87,7	193,0	187,5	412,5

Coefficient of friction μ : Steel: approx. 0,60 | PE: approx. 0,35 | HDPE: approx. 0,30

* = coefficient of friction μ :0,5

U-belts / Shore 92 A / 40 D

PATENT
WELDABLE
reinforcement



approx. 88° Shore A

Recommended pretension
0,5...2 %

PU 85 A ultramarine blue, reinforced glass fiber

Order No.	Profile dimension mm	Cross Section cm ²	approx. Weight kg/100 m	Standard Roll		Recommended Min. pulley Ø		Fmax/belt (Standard)*	
				m	ft	mm	inch	kg	lbs
FBZKP85A13	13 x 8	0,82	10,0	50	164	125	4,9	32,8	72,2
FBZKP85A17 (Nut)	17 x 11	1,46	18,0	50	164	180	7,1	55,4	122,0
FBZKP85A22 (Nut)	22 x 14	2,40	29,0	50	164	220	8,7	92,4	203,3

* = coefficient of friction μ : 0,5

Coefficient of friction μ : Steel: approx. 0,60 | PE: approx. 0,35 | HDPE: approx. 0,30



approx. 92° Shore A

Recommended pretension
3...5 %

PU 90 A white smooth

Order No.	Profile dimension mm	Cross Section cm ²	approx. Weight kg/100 m	Standard Roll		Recommended Min. pulley Ø		Fmax/belt (Standard)*	
				m	ft	mm	inch	kg	lbs
FBKP90A08	8 x 5 (M)	0,32	4,0	100	328	60	2,4	15,4	33,8
FBKP90A10	10 x 6 (Z)	0,48	6,0	50	164	80	3,2	23,0	50,7
FBKP90A13	13 x 8 (A)	0,82	10,0	50	164	105	4,2	38,4	84,5
FBKP90A17	17 x 11 (B)	1,46	18,0	50	164	140	5,5	69,1	152,1
FBKP90A22	22 x 14 (C)	2,40	29,0	50	164	200	7,9	115,2	253,4
FBKP90A32 (nature)	32 x 20 (D)	5,00	62,0	25	82	320	12,6	240,0	528,0

Coefficient of friction μ : Steel: approx. 0,50 | PE: approx. 0,30 | HDPE: approx. 0,25

* = coefficient of friction μ : 0,5



available cogged on request**

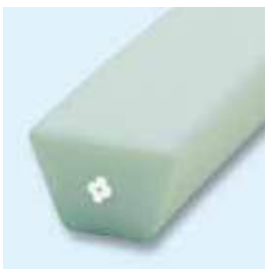

approx. 92° Shore A

Recommended pretension
0,5...2 %

PU 90 A white, reinforcement polyester

Order No.	Profile dimension mm	Cross Section cm ²	approx. Weight kg/100 m	Standard Roll		Recommended Min. pulley Ø		Fmax/belt (Standard)*		Fmax/belt (overlap)	
				m	ft	mm	inch	kg	lbs	kg	lbs
FBZKP90A08P	8 x 5	0,32	4,0	100	328	80	3,1	15,4	33,8	30,0	66,0
FBZKP90A10P	10 x 6	0,48	6,0	50	164	100	3,9	23,0	50,7	45,0	99,0
FBZKP90A13P	13 x 8	0,82	10,0	50	164	120	4,7	38,4	84,5	67,5	148,5
FBZKP90A17P	17 x 11	1,46	18,0	50	164	160	6,3	69,1	152,1	120,0	264,0
FBZKP90A22P	22 x 14	2,40	29,0	50	164	230	9,0	115,2	253,4	202,5	445,5

Coefficient of friction μ : Steel: approx. 0,50 | PE: approx. 0,30 | HDPE: approx. 0,25

* = coefficient of friction μ : 0,5



approx. 92° Shore A

Recommended pretension
0,5...2 %

PU 90 A white, reinforced polyester, with cogged bottom**

Order No.	Profile dimension mm	Cross Section cm ²	approx. Weight kg/100 m	Standard Roll		Recommended Min. pulley Ø		Fmax/belt (Standard)*	
				m	ft	mm	inch	kg	lbs
FBZKP90A13PV	13 x 8	0,82	10,0	50	164	90	3,5	32,6	71,8
FBZKP90A17PV	17 x 11	1,46	18,0	50	164	120	4,7	58,8	129,3
FBZKP90A22PV	22 x 14	2,40	29,0	50	164	175	7,0	97,9	215,4

Coefficient of friction μ : Steel: approx. 0,50 | PE: approx. 0,30 | HDPE: approx. 0,25

* = coefficient of friction μ : 0,5

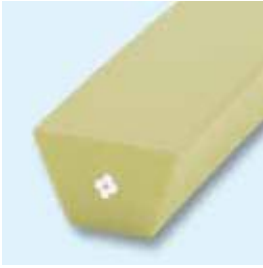

approx. 95° Shore A

Recommended pretension
0,5...2 %

PU 95 A beige, reinforced polyester

Order No.	Profile dimension mm	Cross Section cm ²	approx. Weight kg/100 m	Standard Roll		Recommended Min. pulley Ø		Fmax/belt (Standard)*		Fmax/belt (overlap)	
				m	ft	mm	inch	kg	lbs	kg	lbs
FBKM13ABGA	13 x 8	0,82	10,0	50	164	130	5,0	40,0	88,0	67,5	148,5
FBKM17BBGA	17 x 11	1,46	18,0	50	164	175	6,8	72,0	158,4	120,0	264,0
FBKM22CBGA	22 x 14	2,40	29,0	50	164	250	9,7	120,0	264,0	202,0	444,4

Coefficient of friction μ : Steel: approx. 0,45 | PE: approx. 0,25 | HDPE: approx. 0,20

* = coefficient of friction μ :0,5



approx. 95° Shore A

Recommended pretension
0,5...2 %

PU 95 A beige, reinforced polyester, with cogged bottom**

Order No.	Profile dimension mm	Cross Section cm ²	approx. Weight kg/100 m	Standard Roll		Recommended Min. pulley Ø		Fmax/belt (Standard)*	
				m	ft	mm	inch	kg	lbs
FBZKP95A13PV	13 x 8	0,82	10,0	50	164	100	3,9	34,0	74,8
FBZKP95A17PV	17 x 11	1,46	18,0	50	164	130	5,0	61,2	134,6
FBZKP95A22PV	22 x 14	2,40	29,0	50	164	190	7,4	102,0	224,4

Coefficient of friction μ : Steel: approx. 0,45 | PE: approx. 0,25 | HDPE: approx. 0,20

* = coefficient of friction μ :0,5



40° Shore D - approx. 95° Shore A

Recommended pretension
2...4 %

Polyester TPE 40 D beige smooth



Order No.	Profile dimension mm	Cross Section cm ²	approx. Weight kg/100 m	Standard Roll		Recommended Min. pulley Ø		Fmax/belt (Standard)*	
				m	ft	mm	inch	kg	lbs
FBKR08MBG	8 x 5 (M)	0,32	4,0	100	328	60	2,4	19,3	42,4
FBKR10ZBG	10 x 6 (Z)	0,48	6,0	50	164	80	3,2	28,9	63,6
FBKR13ABG	13 x 8 (A)	0,82	10,0	50	164	105	4,2	49,4	108,6
FBKR17BBG	17 x 11 (B)	1,46	18,0	50	164	140	5,5	87,7	193,0
FBKR22CBG	22 x 14 (C)	2,40	29,0	50	164	200	7,9	144,5	317,9

Coefficient of friction μ : Steel: approx. 0,50 | PE: approx. 0,25 | HDPE: approx. 0,20 | FDA/EC/USDA compliant



available cogged on request**

* = coefficient of friction μ :0,5

** The cogged bottom enables the belt to run over smaller pulleys (approx. 25% smaller) but also decreases the maximum working tension (approx. 15%).
Cogged V-Belts cannot be used as timing belts.

V-belts / Shore 55 D



55° Shore D · approx. 100° Shore A
Recommended pretension
2...4 %

Polyester TPE 55 D beige smooth



Order No.	Profile dimension mm	Cross Section cm ²	approx. Weight kg/100 m	Standard Roll		Recommended Min. pulley Ø		Fmax/belt (Standard)*	
				m	ft	mm	inch	kg	lbs
FBKH55D08B (beige)	8 x 5 (M)	0,32	4,0	100	328	80	3,2	25,6	56,3
FBKH55D10B (beige)	10 x 6 (Z)	0,48	6,0	50	164	105	4,2	38,4	84,5
FBKH55D13B (beige)	13 x 8 (A)	0,82	10,0	50	164	125	5	64,0	140,8
FBKH55D17 (blau)	17 x 11 (B)	1,46	18,0	50	164	175	7	116,8	257,0
FBKH55D22B (beige)	22 x 14 (C)	2,40	29,0	50	164	235	9,4	192,0	422,4

Coefficient of friction μ : Steel: approx. 0,35 | PE: approx. 0,20 | HDPE: approx. 0,15 | FDA/EC/USDA compliant



available cogged on request**

* = coefficient of friction μ :0,5

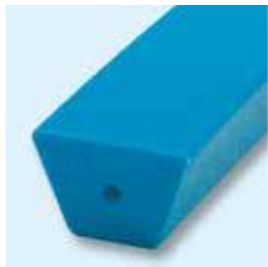

55° Shore D · approx. 100° Shore A
Recommended pretension
2...4 %

Polyester TPE 55 D blue smooth



Order No.	Profile dimension mm	Cross Section cm ²	approx. Weight kg/100 m	Standard Roll		Recommended Min. pulley Ø		Fmax/belt (Standard)*	
				m	ft	mm	inch	kg	lbs
FBKH55D08B (beige)	8 x 5 (M)	0,32	4,0	100	328	80	3,2	25,6	56,3
FBKH55D10B (beige)	10 x 6 (Z)	0,48	6,0	50	164	105	4,2	38,4	84,5
FBKH55D13B (beige)	13 x 8 (A)	0,82	10,0	50	164	125	5	64,0	140,8
FBKH55D17 (blau)	17 x 11 (B)	1,46	18,0	50	164	175	7	116,8	257,0
FBKH55D22B (beige)	22 x 14 (C)	2,40	29,0	50	164	235	9,4	192,0	422,4

Coefficient of friction μ : Steel: approx. 0,35 | PE: approx. 0,20 | HDPE: approx. 0,15 | FDA/EC/USDA compliant



available cogged on request**

* = coefficient of friction μ :0,5



55° Shore D · approx. 100° Shore A
Recommended pretension
0,5...2 %

Polyester TPE 55 D beige, reinforced polyester



Order No.	Profile dimension mm	Cross Section cm ²	approx. Weight kg/100 m	Standard Roll		Recommended Min. pulley Ø		Fmax/belt (Standard)*		Fmax/belt (overlap)	
				m	ft	mm	inch	kg	lbs	kg	lbs
FBKH55D10P	10 x 6	0,48	6,0	50	164	110	4,4	48	105,6	70	154
FBKH55D13P	13 x 8	0,82	10,0	50	164	130	5,2	80	176	110	242
FBKH55D17P	17 x 11	1,46	18,0	50	164	180	7,2	146	321,2	180	396
FBKH55D22P	22 x 14	2,40	29,0	50	164	250	10	240	528	300	660

Coefficient of friction μ : Steel: approx. 0,35 | PE: approx. 0,20 | HDPE: approx. 0,15 | FDA/EC/USDA compliant



available cogged on request**

* = coefficient of friction μ :0,5

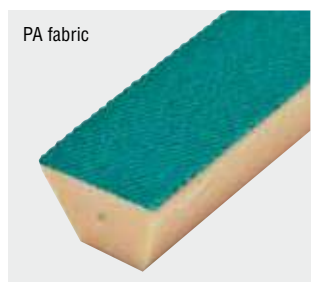
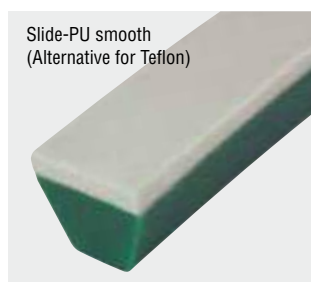
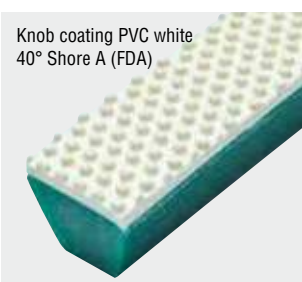
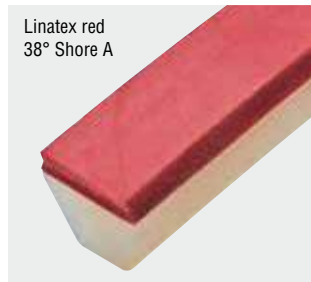
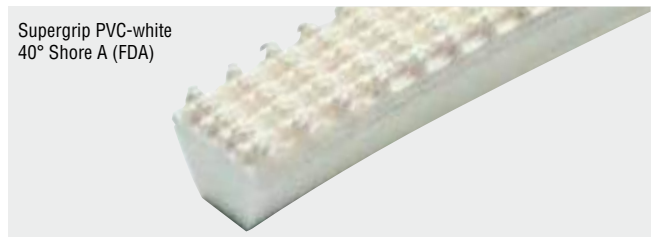
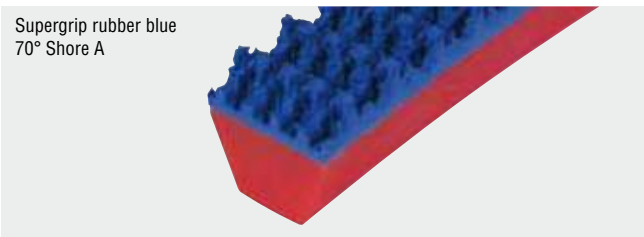
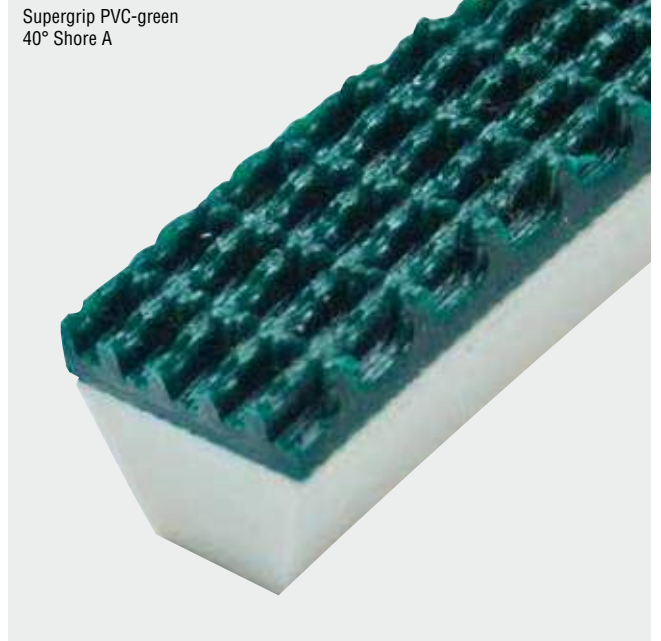
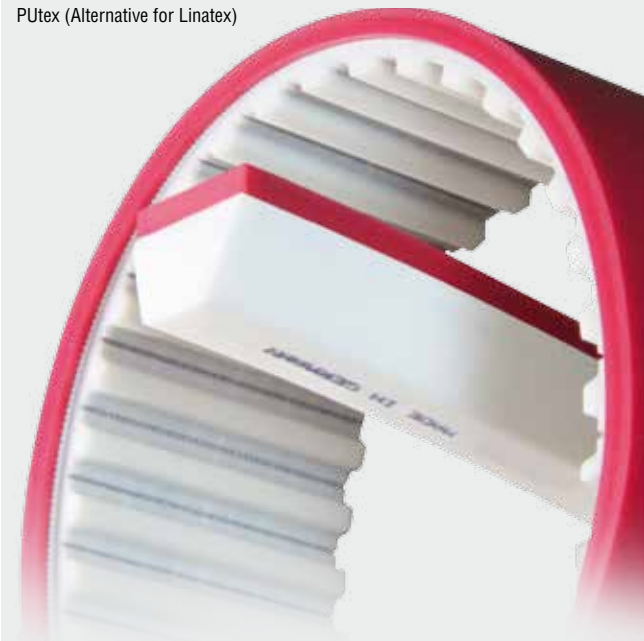

Twin-V-belts | Shore 80, 84, 88 A

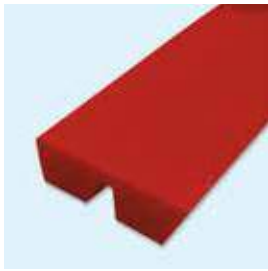

approx. 80° Shore A

Recommended pretension
3...6 %

PU 75 A red smooth

Order No.	Profile dimension mm	Cross Section cm ²	approx. Weight kg/100 m	Standard Roll		Recommended Min. pulley ∅		Fmax/belt (Standard)*	
				m	ft	mm	inch	kg	lbs
FBS75A21X8	21 x 8	1,2	13,9	30	98,4	60	2,3	23,0	50,6

* = coefficient of friction μ :0,5

Coefficient of friction μ : Steel: approx. 0,70 | PE: approx. 0,40 | HDPE: approx. 0,35

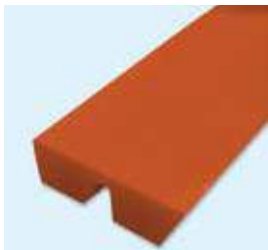

approx. 84° Shore A

Recommended pretension
3...6 %

PU 80 A orange smooth



Order No.	Profile dimension mm	Cross Section cm ²	approx. Weight kg/100 m	Standard Roll		Recommended Min. pulley ∅		Fmax/belt (Standard)*	
				ft	(m)	mm	inch	kg	lbs
FBSJ24X680GB	24 x 6,8	1,2	14,9	100	30,48	60	2,4	28,8	63,4
FBSJ30X80G	30 x 8	1,9	22,4	100	30,48	80	3,1	45,6	100,3

* = coefficient of friction μ :0,5

Coefficient of friction μ : Steel: approx. 0,65 | PE: approx. 0,35 | HDPE: approx. 0,30 | FDA/EC/USDA compliant



approx. 88° Shore A

Recommended pretension
0,5...2 %

PU 85 A mint green, reinforced polyester

Order No.	Profile dimension mm	Cross Section cm ²	approx. Weight kg/100 m	Standard Roll		Recommended Min. pulley ∅		Fmax/belt (Standard)*		Fmax/belt (overlap)	
				ft	(m)	mm	inch	kg	lbs	kg	lbs
FBSK30X8GGA	30 x 8	1,9	22,4	100	30,48	100	3,9	69,8	153,5	102,6	225,7

* = coefficient of friction μ :0,5

Coefficient of friction μ : Steel: approx. 0,60 | PE: approx. 0,35 | HDPE: approx. 0,30

Coated Twin-V-belts

PU-Foil Coating

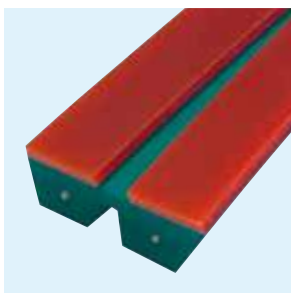

PU 85 A Twin-V-belt (30x8mm) with reinforced polyester and PU 75 A foil coating

PVC-Supergrip Coating

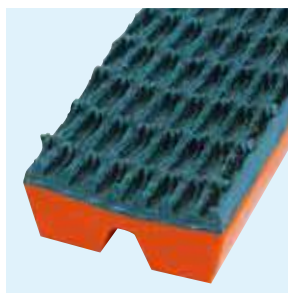

PU 75 A Twin-B-belt (24x6,8mm) with PVC-Supergrip coating.

Relined Neopren Coating

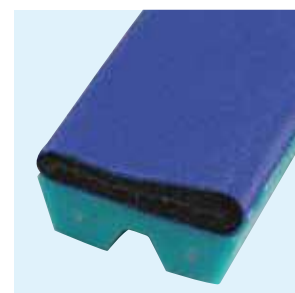

PU 85 A Twin-B-belt (30x8mm) with reinforced polyester and relined neoprene coating. Especially for PET bottle transport / guide.

2 compound extrusion

Form 2 with notch

2K, PU 75 A / PU 80 A

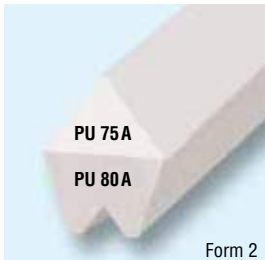

Order No.	Profile dimension mm	Cross Section cm ²	approx. Weight kg/100 m	Standard Roll		Recommended Min. pulley \varnothing		Fmax/belt (Standard)*	
				m	ft	mm	inch	kg	lbs
FBZSP85A17K2	17 x 19	2,0	24,4	30	98,4	160	6,4	48,0	105,6
FBZSP85A22K2	22 x 25	3,5	42,3	30	98,4	200	8,0	84,0	184,8

Form 2
approx. 80/84° Shore A
Recommended pretension
3...6 %

* = coefficient of friction μ :0,5

Coefficient of friction μ : Steel: approx. 0,65 | PE: approx. 0,35 | HDPE: approx. 0,30

2 compound extrusion

Form 2 with notch

2K, PU 75 A / PU 80 A reinforced aramid

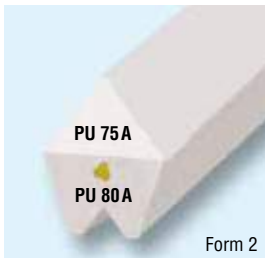

Order No.	Profile dimension mm	Cross Section cm ²	approx. Weight kg/100 m	Standard Roll		Recommended Min. pulley \varnothing		Fmax/belt (Standard)*	
				m	ft	mm	inch	kg	lbs
FBZSP85A17K2	17 x 19	2,0	24,4	30	98,4	170	6,8	48,0	105,6
FBZSP85A22K2	22 x 25	3,5	42,3	30	98,4	210	8,4	84,0	184,8

Form 2
approx. 80/84° Shore A
Recommended pretension
0,5...2 %

* = coefficient of friction μ :0,5

Coefficient of friction μ : Steel: approx. 0,65 | PE: approx. 0,35 | HDPE: approx. 0,30

Form 2 without notch

PU 80 A transparent



Order No.	Profile dimension mm	Cross Section cm ²	approx. Weight kg/100 m	Standard Roll		Recommended Min. pulley \varnothing		Fmax/belt (Standard)*	
				m	ft	mm	inch	kg	lbs
FBBJ22X25TGO	22 x 25	3,65	43,8	30	98,4	210	8,4	87,6	192,7

Form 2
approx. 84° Shore A
Recommended pretension
3...6 %

* = coefficient of friction μ :0,5

Coefficient of friction μ : Steel: approx. 0,65 | PE: approx. 0,35 | HDPE: approx. 0,30

Form 2 without notch

PU 80 A transparent, reinforced polyester

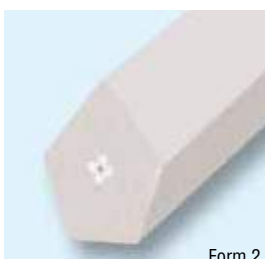

Order No.	Profile dimension mm	Cross Section cm ²	approx. Weight kg/100 m	Standard Roll		Recommended Min. pulley \varnothing		Fmax/belt (Standard)*	
				m	ft	mm	inch	kg	lbs
FBBJ22X25TGA	22 x 25	3,65	43,8	30	98,4	210	8,4	87,6	192,7

Form 2
approx. 84° Shore A
Recommended pretension
0,5 -2 %

* = coefficient of friction μ :0,5

Coefficient of friction μ : Steel: approx. 0,65 | PE: approx. 0,35 | HDPE: approx. 0,30

Rigde-top-V-belts | Shore 88 A



Form 1

approx. 88° Shore A

Form 1 without notch

PU 85 A green

Order No.	Profile dimension mm	Cross Section cm ²	approx. Weight kg/100 m	Standard Roll		Recommended Min. pulley Ø		Fmax/belt (Standard)*	
				m	ft	mm	inch	kg	lbs
FBSP85A170N	17 x 19	1,95	23,6	30	98,4	180	7,2	53,8	118,4
FBSP85A220N	22 x 25	3,26	39,1	30	98,4	220	8,8	90,0	198,0

Recommended pretension: 3...6 %

* = coefficient of friction μ : 0,5

Coefficient of friction μ : Steel: approx. 0,60 | PE: approx. 0,35 | HDPE: approx. 0,30



Form 2

approx. 88° Shore A

Form 2 without notch

PU 85 A green

Order No.	Profile dimension mm	Cross Section cm ²	approx. Weight kg/100 m	Standard Roll		Recommended Min. pulley Ø		Fmax/belt (Standard)*	
				m	ft	mm	inch	kg	lbs
FBAK17X19GG	17 x 19	2,13	25,6	30	98,4	190	7,6	59,0	129,8
FBAK22X25GG	22 x 25	3,65	43,8	30	98,4	240	9,6	100,7	221,6

Recommended pretension: 3...6 %

* = coefficient of friction μ : 0,5

Coefficient of friction μ : Steel: approx. 0,60 | PE: approx. 0,35 | HDPE: approx. 0,30



Form 2

approx. 88° Shore A

Form 2 without notch

PU 85 A green, reinforced polyester

Order No.	Profile dimension mm	Cross Section cm ²	approx. Weight kg/100 m	Standard Roll		Recommended Min. pulley Ø		Fmax/belt (Standard)*	
				m	ft	mm	inch	kg	lbs
FBBK17X19GGA	17 x 19	2,13	25,6	30	98,4	190	7,6	59,0	129,8
FBBK22X25GGA	22 x 25	3,65	43,8	30	(98,4)	240	9,6	100,7	221,6

Recommended pretension: 0,5...2 %

* = coefficient of friction μ : 0,5

Coefficient of friction μ : Steel: approx. 0,60 | PE: approx. 0,35 | HDPE: approx. 0,30

PATENT
WELDABLE
reinforcement



Form 1

approx. 88° Shore A

Form 1 without notch

PU 85 A blue, reinforced glass fiber

Order No.	Profile dimension mm	Cross Section cm ²	approx. Weight kg/100 m	Standard Roll		Recommended Min. pulley Ø		Fmax/belt (Standard)*	
				m	ft	mm	inch	kg	lbs
FBZSP85A170N	17 x 19	1,95	23,63	30	98,4	240	9,6	78,0	171,6
FBZSP85A220N	22 x 25	3,26	39,1	30	98,4	280	11,2	130,4	286,9

Recommended pretension: 0,5...2 %

* = coefficient of friction μ : 0,5

Coefficient of friction μ : Steel: approx. 0,60 | PE: approx. 0,35 | HDPE: approx. 0,30

PATENT
WELDABLE
reinforcement



Form 2

approx. 88° Shore A

Form 2 without notch

PU 85 A blue, reinforced glass fiber

Order No.	Profile dimension mm	Cross Section cm ²	approx. Weight kg/100 m	Standard Roll		Recommended Min. pulley Ø		Fmax/belt (Standard)*	
				m	ft	mm	inch	kg	lbs
FBBK17X19LGA	17 x 19	2,13	25,6	30	98,4	260	10,4	85,2	187,4
FBBK22X25LGA	22 x 25	3,65	43,8	30	98,4	300	12	146,0	321,2

Recommended pretension: 0,5 - 2 %

* = coefficient of friction μ : 0,5

Coefficient of friction μ : Steel: approx. 0,60 | PE: approx. 0,35 | HDPE: approx. 0,30

Form 1 without notch

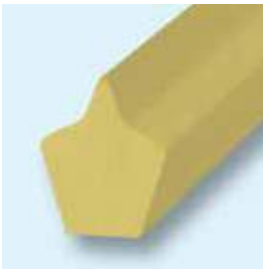

PU 95 A beige

Order No.	Profile dimension mm	Cross Section cm ²	approx. Weight kg/100 m	Standard Roll		Recommended Min. pulley Ø		Fmax/belt (Standard)*	
				m	ft	mm	inch	kg	lbs
FBAM17x19BG	17 x 19	1,95	23,6	30	98,4	200	8	97,5	214,5
FBAM22x25BG	22 x 25	3,26	39,1	30	98,4	250	10	163,0	358,6

* = coefficient of friction μ :0,5

approx. 95° Shore A

Recommended pretension
3...5 %

Coefficient of friction μ : Steel: approx. 0,45 | PE: approx. 0,25 | HDPE: approx. 0,20

Form 2 without notch



PU 95 A beige

Order No.	Profile dimension mm	Cross Section cm ²	approx. Weight kg/100 m	Standard Roll		Recommended Min. pulley Ø		Fmax/belt (Standard)*	
				m	ft	mm	inch	kg	lbs
FBBM17x19BG	17 x 19	2,13	25,6	30	98,4	210	8,4	106,5	234,3
FBBM22x25BG	22 x 25	3,65	43,8	30	98,4	260	10,4	182,5	401,5

* = coefficient of friction μ :0,5

approx. 95° Shore A

Recommended pretension
3...5 %

Coefficient of friction μ : Steel: approx. 0,45 | PE: approx. 0,25 | HDPE: approx. 0,20

Form 1 without notch

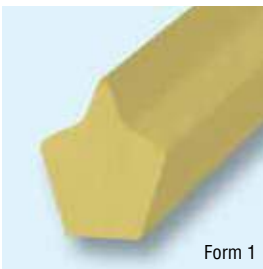

Polyester TPE 40 D beige



Order No.	Profile dimension mm	Cross Section cm ²	approx. Weight kg/100 m	Standard Roll		Recommended Min. pulley Ø		Fmax/belt (Standard)*	
				m	ft	mm	inch	kg	lbs
FBAR17X19BG	17 x 19	1,95	23,6	30	98,4	210	8,4	117,4	258,3
FBAR22X24BG	22 x 25	3,26	39,1	25	82,0	260	10,4	196,3	431,8

* = coefficient of friction μ :0,5

40° Shore D - approx. 95° Shore A

Recommended pretension
2...4 %

Coefficient of friction μ : Steel: approx. 0,50 | PE: approx. 0,25 | HDPE: approx. 0,20 | FDA/EC/USDA compliant

Form 2 without notch

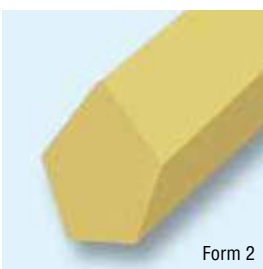

Polyester TPE 40 D beige



Order No.	Profile dimension mm	Cross Section cm ²	approx. Weight kg/100 m	Standard Roll		Recommended Min. pulley Ø		Fmax/belt (Standard)*	
				m	ft	mm	inch	kg	lbs
FBBR17X19BG	17 x 19	2,13	25,6	30	98,4	220	8,8	128,2	282,1
FBBR22X25BG	22 x 25	3,65	43,8	30	98,4	280	11,2	219,7	483,4

* = coefficient of friction μ :0,5

40° Shore D - approx. 95° Shore A

Recommended pretension
2...4 %

Coefficient of friction μ : Steel: approx. 0,50 | PE: approx. 0,25 | HDPE: approx. 0,20 | FDA/EC/USDA compliant

T-Profile | Shore 80, 84 A

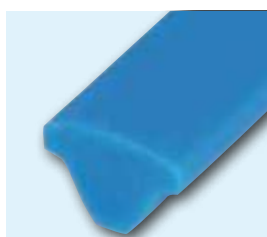

approx. 80° Shore A

Recommended pretension
4...8 %

T-Profile PU 75 A sky blue smooth (8 x 5 mm)



Order No.	Profile dimension	Cross Section cm ²	approx. Weight kg/100 m	Standard Roll		Recommended Min. pulley ∅		Fmax/belt (Standard)*	
	mm			m	ft	mm	inch	kg	lbs
FBSP75A8X5HI	8 x 5	0,25	3,1	50	164	30	1,2	6,0	13,2

* = coefficient of friction μ :0,5

Coefficient of friction μ : Steel: approx. 0,70 | PE: approx. 0,40 | HDPE: approx. 0,35 | FDA/EC/USDA compliant

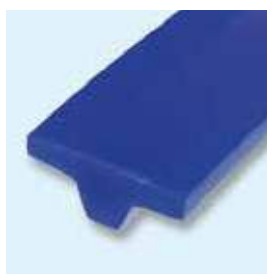

approx. 84° Shore A

Recommended pretension
4...8 %

T-Profile PU 80 A ultramarine blue smooth (10 x 4,5 mm)



Order No.	Profile dimension	Cross Section cm ²	approx. Weight kg/100 m	Standard Roll		Recommended Min. pulley ∅		Fmax/belt (Standard)*	
	mm			m	ft	mm	inch	kg	lbs
FBT12X45X10L	10 x 4,5	0,27	3,3	50	164	40	1,6	8,1	17,8

* = coefficient of friction μ :0,5

Coefficient of friction μ : Steel: approx. 0,65 | PE: approx. 0,35 | HDPE: approx. 0,30 | FDA/EC/USDA compliant

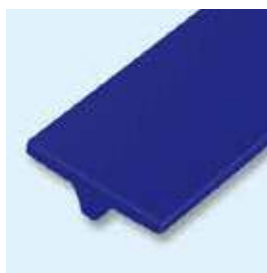

approx. 84° Shore A

Recommended pretension
4...8 %

T-Profile PU 80 A ultramarine blue smooth (15 x 5 mm)



Order No.	Profile dimension	Cross Section cm ²	approx. Weight kg/100 m	Standard Roll		Recommended Min. pulley ∅		Fmax/belt (Standard)*	
	mm			m	ft	mm	inch	kg	lbs
FBTJ15X5L	15 x 5	0,40	4,8	50	164	40	1,6	9,6	21,1

* = coefficient of friction μ :0,5

Coefficient of friction μ : Steel: approx. 0,65 | PE: approx. 0,35 | HDPE: approx. 0,30 | FDA/EC/USDA compliant



approx. 84° Shore A

Recommended pretension
3...6 %

3L T-Top PU 80 A orange smooth (14,3 x 7,5 mm)



Order No.	Profile dimension	Cross Section cm ²	approx. Weight kg/100 m	Standard Roll		Recommended Min. pulley ∅		Fmax/belt (Standard)*	
	mm			ft	(m)	mm	inch	kg	lbs
FBTJ142X750	14,3 x 7,5	0,72	8,7	100	30,48	80	3,1	17,3	38,1

* = coefficient of friction μ :0,5

Coefficient of friction μ : Steel: approx. 0,65 | PE: approx. 0,35 | HDPE: approx. 0,30 | FDA/EC/USDA compliant

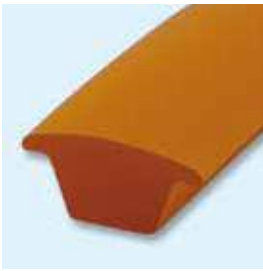

approx. 84° Shore A
Recommended pretension 3...6 %

Crown Top PU 80 A orange smooth (14,3 x 6,3 mm)



Order No.	Profile dimension mm	Cross Section cm ²	approx. Weight kg/100 m	Standard Roll		Recommended Min. pulley Ø		Fmax/belt (Standard)*	
				ft	(m)	mm	inch	kg	lbs
FBTJ143X630G	14,3 x 6,3	0,58	7,0	100	30,48	80	3,1	13,9	30,6

* = coefficient of friction μ :0,5

Coefficient of friction μ : Steel: approx. 0,65 | PE: approx. 0,35 | HDPE: approx. 0,30 | FDA/EC/USDA compliant



approx. 84° Shore A
Recommended pretension 3...6 %

PU 80 A T-Profile half-round orange smooth



Order No.	Profile dimension mm	Cross Section cm ²	approx. Weight kg/100 m	Standard Roll		Recommended Min. pulley Ø		Fmax/belt (Standard)*	
				m	ft	mm	inch	kg	lbs
FBTJ192x550G	19,2 x 5,5	0,65	7,8	30	98,4	40	1,6	15,6	34,3

* = coefficient of friction μ :0,5

Coefficient of friction μ : Steel: approx. 0,65 | PE: approx. 0,35 | HDPE: approx. 0,30 | FDA/EC/USDA compliant



approx. 88° Shore A
Recommended pretension 3...6 %

T-Profile PU 85 A ultramarine blue smooth (9,5 x 3,5 mm)



Order No.	Profile dimension mm	Cross Section cm ²	approx. Weight kg/100 m	Standard Roll		Recommended Min. pulley Ø		Fmax/belt (Standard)*	
				m	ft	mm	inch	kg	lbs
FBTK95X35L	9,5 x 3,5	0,20	2,4	50	164	50	2,0	5,2	11,4

* = coefficient of friction μ :0,5

Coefficient of friction μ : Steel: approx. 0,65 | PE: approx. 0,35 | HDPE: approx. 0,30 | FDA/EC/USDA compliant

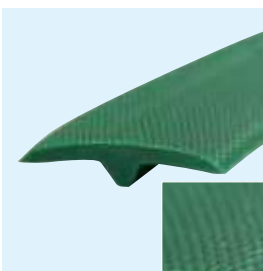

approx. 88° Shore A
Recommended pretension 3...6 %

T-Profile PU 85 A for packaging machines (25 x 5 mm)

Order No.	Profile dimension mm	Cross Section cm ²	approx. Weight kg/100 m	Standard Roll		Recommended Min. pulley Ø		Fmax/belt (Standard)*	
				m	ft	mm	inch	kg	lbs
FBTK25X5GW01	25 x 5	0,58	7,0	50	164	50	2,0	16,0	35,2

* = coefficient of friction μ :0,5

Coefficient of friction μ : Steel: approx. 0,60 | PE: approx. 0,35 | HDPE: approx. 0,30

T-Profiles / Shore 88 A

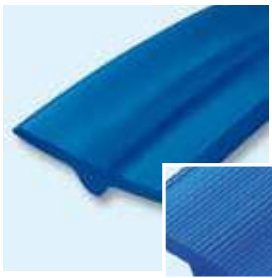

T-Profile PU 85 A sapphire blue smooth / ribbed** (25 x 5 mm)



Order No.	Profile dimension mm	Cross Section cm ²	approx. Weight kg/100 m	Standard Roll		Recommended Min. pulley Ø		Fmax/belt (Standard)*	
				m	ft	mm	inch	kg	lbs
FBSP85A25X5B	25 x 5	0,59	7,3	30	98,4	50	2,0	15,2	33,4
FBTK25X5LGA (gerillt)	25 x 5	0,59	7,3	30	98,4	50	2,0	15,2	33,4

* = coefficient of friction μ :0,5

approx. 88° Shore A

Recommended pretension
3...6 %

Coefficient of friction μ : Steel: approx. 0,60 | PE: approx. 0,35 | HDPE: approx. 0,30 | FDA/EC/USDA compliant



T-Profile PU 85 A white (20 x 8 mm)



Order No.	Profile dimension mm	Cross Section cm ²	approx. Weight kg/100 m	Standard Roll		Recommended Min. pulley Ø		Fmax/belt (Standard)*	
				m	ft	mm	inch	kg	lbs
FBSP85A20X8W	20x8	0,83	10,0	30	98,4	100	4,0	21,4	47,1

* = coefficient of friction μ :0,5

approx. 88° Shore A

Recommended pretension
3...6 %

Coefficient of friction μ : Steel: approx. 0,60 | PE: approx. 0,35 | HDPE: approx. 0,30 | FDA/EC/USDA compliant

T-Profil 20x8 sapphire blue FBSP85A20X8 on request

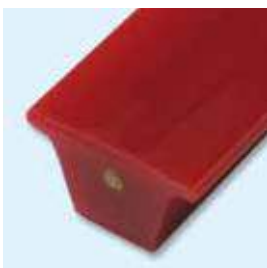

T-V-belt PU 90 A red, reinforced aramid

Order No.	Profile dimension mm	Cross Section cm ²	approx. Weight kg/100 m	Standard Roll		Recommended Min. pulley Ø		Fmax/belt (Standard)*	
				m	ft	mm	inch	kg	lbs
FBSL17X13X25	17 x 13 x 25	1,88	23,0	50	164	210	8,3	90,2	198,4
FBSL22X16X25	22 x 16 x 25	2,82	340	30	98,4	280	11,0	135,4	297,9

* = coefficient of friction μ :0,5

approx. 92° Shore A

Recommended pretension
0,5...2 %

Coefficient of friction μ : Steel: approx. 0,50 | PE: approx. 0,30 | HDPE: approx. 0,25



Available cogged on request**



Corn belt PU 80 A orange smooth with/without serrations



Order No.	Profile dimension mm	Cross Section cm ²	approx. Weight kg/100 m	Standard Roll		Recommended Min. pulley Ø		Fmax/belt (Standard)*	
				ft	(m)	mm	inch	kg	lbs
FBSJ8X330G*	33 x 8	1,9	22,8	100	30,48	50	2,0	45,6	100,3
FBSJ8X330GA	33 x 8	1,9	22,8	100	30,48	50	2,0	45,6	100,3

* = coefficient of friction μ :0,5

approx. 84° Shore A

Recommended pretension
3...6 %

Coefficient of friction μ : Steel: approx. 0,65 | PE: approx. 0,35 | HDPE: approx. 0,30 | FDA/EC/USDA compliant

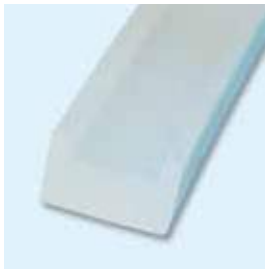

U-Profile PU 85 A milky smooth



Order No.	Profile dimension mm	Cross Section cm ²	approx. Weight kg/100 m	Standard Roll		Recommended Min. pulley Ø		Fmax/belt (Standard)*	
				ft		mm	inch	kg	lbs
FBSP85A180S1	18 x 11,8	1,70	20,0	1 x 30`5` / pcs.		120	4,7	43,9	96,6
FBSP85A180S6	18 x 11,8	1,70	20,0	6 x 30`5` / pcs.		120	4,7	43,9	96,6

Recommended pretension: 3...6 %

* = coefficient of friction μ :0.5

approx. 88° Shore A

Coefficient of friction μ : Steel: approx. 0,60 | PE: approx. 0,35 | HDPE: approx. 0,30 | FDA/EC/USDA compliant

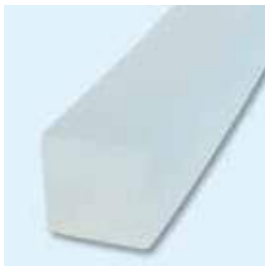

Square-Profile PU 85 A milky smooth



Order No.	Profile dimension mm	Cross Section cm ²	approx. Weight kg/100 m	Standard Roll		Recommended Min. pulley Ø		Fmax/belt (Standard)*	
				ft		mm	inch	kg	lbs
FBSP85A118S1	11,8 x 11,8	1,39	16,7	1 x 30`5` / pcs.		120	4,7	35,9	79,0
FBSP85A118S6	11,8 x 11,8	1,39	16,7	6 x 30`5` / pcs.		120	4,7	35,9	79,0

Recommended pretension: 3...6 %

* = coefficient of friction μ :0.5

approx. 88° Shore A

Coefficient of friction μ : Steel: approx. 0,60 | PE: approx. 0,35 | HDPE: approx. 0,30 | FDA/EC/USDA compliant



PU 75 A sky blue smooth with vaulted top



Order No.	Profile dimension mm	Cross Section cm ²	approx. Weight kg/100 m	Standard Roll		Recommended Min. pulley Ø		Fmax/belt (Standard)*	
				m	ft	mm	inch	kg	lbs
FBSP75A0865W	8 x 6,5 (M)	0,39	4,6	50	164	40	1,6	10,0	22,0

Recommended pretension: 4...8 %

* = coefficient of friction μ :0.5

approx. 80° Shore A

Coefficient of friction μ : Steel: approx. 0,70 | PE: approx. 0,40 | HDPE: approx. 0,35 | FDA/EC/USDA compliant

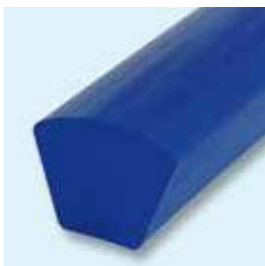

PU 80 A ultramarine blue smooth with vaulted top



Order No.	Profile dimension mm	Cross Section cm ²	approx. Weight kg/100 m	Standard Roll		Recommended Min. pulley Ø		Fmax/belt (Standard)*	
				m	ft	mm	inch	kg	lbs
FBSP80A0865W	8 x 6,5 (M)	0,39	4,6	50	164	50	2,0	11,0	24,2

Recommended pretension: 4...8 %

* = coefficient of friction μ :0.5

approx. 84° Shore A

Coefficient of friction μ : Steel: approx. 0,65 | PE: approx. 0,35 | HDPE: approx. 0,30 | FDA/EC/USDA compliant

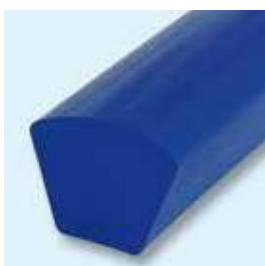

PU 85 A sapphire blue smooth with vaulted top



Order No.	Profile dimension mm	Cross Section cm ²	approx. Weight kg/100 m	Standard Roll		Recommended Min. pulley Ø		Fmax/belt (Standard)*	
				m	ft	mm	inch	kg	lbs
FBSP85A0865W	8 x 6,5 (M)	0,39	4,6	50	164	55	2,2	13,2	29,0

Recommended pretension: 4...8 %

* = coefficient of friction μ :0.5

approx. 88° Shore A

Coefficient of friction μ : Steel: approx. 0,60 | PE: approx. 0,30 | HDPE: approx. 0,25 | FDA/EC/USDA compliant

Special profiles



PU 80 A orange ribbed

Order No.	Profile dimension		Cross Section cm ²	approx. Weight kg/100 m	Standard Roll		Recommended Min. pulley Ø		Fmax/belt (Standard)*	
	mm				ft	(m)	mm	inch	kg	lbs
FBS117BOGR3	17 x 11 (B)		1,46	18,0	100	30,48	110	4,3	43,8	96,4
FBS122COGR3	22 x 14 (C)		2,40	29,0	100	30,48	150	5,9	72,0	158,4

* = coefficient of friction μ :0,5

approx. 84° Shore A

Recommended pretension
4...8 %

Coefficient of friction μ : Steel: approx. 0,65 | PE: approx. 0,35 | HDPE: approx. 0,30 | FDA/EC/USDA compliant



PU 85 A black smooth, reinforced aramid

Order No.	Diameter Ø		Cross Section cm ²	approx. Weight kg/100 m	Standard Roll		Recommended Min. pulley Ø		Fmax/belt (Standard)*		Fmax/belt (overlap)	
	mm	inch			ft	(m)	mm	inch	kg	lbs	kg	lbs
FBZR85A095SA	9,7	3/8	0,71	8,5	600	182,88	95	3,7	24,9	54,8	57,2	125,8

* = coefficient of friction μ :0,5

approx. 88° Shore A

Recommended pretension
0,5...2 %

Coefficient of friction μ : Steel: approx. 0,60 | PE: approx. 0,35 | HDPE: approx. 0,30



PU 85 A sky blue smooth, reinforced aramid

Order No.	Diameter Ø		Cross Section cm ²	approx. Weight kg/100 m	Standard Roll		Recommended Min. pulley Ø		Fmax/belt (Standard)*		Fmax/belt (overlap)	
	mm	inch			ft	(m)	mm	inch	kg	lbs	kg	lbs
FBZR85A095HA	9,7	3/8	0,71	8,5	600	182,88	95	3,7	24,9	54,8	57,2	125,8

* = coefficient of friction μ :0,5

approx. 88° Shore A

Recommended pretension
0,5...2 %

Coefficient of friction μ : Steel: approx. 0,60 | PE: approx. 0,35 | HDPE: approx. 0,30



PU 95 A red smooth, reinforced aramid

Order No.	Diameter Ø		Cross Section cm ²	approx. Weight kg/100 m	Standard Roll		Recommended Min. pulley Ø		Fmax/belt (Standard)*		Fmax/belt (overlap)	
	mm	inch			ft	(m)	mm	inch	kg	lbs	kg	lbs
FBRN095RM	9,7	3/8	0,71	8,5	500	152,4	125	4,7	35,5	78,1	97,5	214,5

* = coefficient of friction μ :0,5

approx. 95° Shore A

Recommended pretension
0,5...2 %

Coefficient of friction μ : Steel: approx. 0,35 | PE: approx. 0,20 | HDPE: approx. 0,15

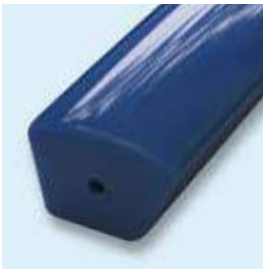

TPE 55 D *bluepower* smooth (roller conveyor)



Order No.	Profile dimension mm	Cross Section cm ²	approx. Weight kg/100 m	Standard Roll		Recommended Min. pulley Ø		Fmax/belt (Standard)*	
				m	ft	mm	inch	kg	lbs
FBKBLP17113W	17 x 11,3	1,49	18,0	50	164	175	7,0	119,2	262,2
FBKBLP1711W2	17 x 11,3	1,49	18,0	100	328	175	7,0	119,2	262,2

* = coefficient of friction μ :0,5

55° Shore D · approx. 100° Shore A

Recommended pretension
2...4 %

Coefficient of friction μ : Steel: approx. 0,35 | PE: approx. 0,20 | HDPE: approx. 0,15 | FDA/EC/USDA compliant

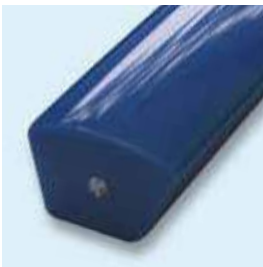

TPE 55 D *bluepower* smooth, reinforced polyester



Order No.	Profile dimension mm	Cross Section cm ²	approx. Weight kg/100 m	Standard Roll		Recommended Min. pulley Ø		Fmax/belt (Standard)*		Fmax/belt (overlap)	
				m	ft	mm	inch	kg	lbs	kg	lbs
FBKBLP1711W3	17 x 11,3	1,49	18,0	100	328	180	7,1	119,2	262,2	150,0	330,0

* = coefficient of friction μ :0,5

55° Shore D · approx. 100° Shore A

Recommended pretension
0,5...2 %

Coefficient of friction μ : Steel: approx. 0,35 | PE: approx. 0,20 | HDPE: approx. 0,15 | FDA/EC/USDA compliant



TPE 55 D beige smooth with chamfer (roller conveyor)



Order No.	Profile dimension mm	Cross Section cm ²	approx. Weight kg/100 m	Standard Roll		Recommended Min. pulley Ø		Fmax/belt (Standard)*	
				m	ft	mm	inch	kg	lbs
FBKH55D17115	17 x 11,4	1,45	18,0	100	328	175	7,0	116,0	255,2

* = coefficient of friction μ :0,5

55° Shore D · approx. 100° Shore A

Recommended pretension
2...4 %

Coefficient of friction μ : Steel: approx. 0,35 | PE: approx. 0,20 | HDPE: approx. 0,15 | FDA/EC/USDA compliant



TPE 55 D beige smooth with chamfer, reinforced polyester



Order No.	Profile dimension mm	Cross Section cm ²	approx. Weight kg/100 m	Standard Roll		Recommended Min. pulley Ø		Fmax/belt (Standard)*		Fmax/belt (overlap)	
				m	ft	mm	inch	kg	lbs	kg	lbs
FBKS17115BGA	17 x 11,4	1,45	18,0	100	328	180	7,1	116,0	255,2	150,0	330,0

* = coefficient of friction μ :0,5

55° Shore D · approx. 100° Shore A

Recommended pretension
0,5...2 %



Coefficient of friction μ : Steel: approx. 0,35 | PE: approx. 0,20 | HDPE: approx. 0,15 | FDA/EC/USDA compliant



CUSTOM-MADE PROFILES

If a standard profile is no longer sufficient for the demands of your application, then BEHAbelt offers you the unique option of developing a customised product.

According to your specifications and your design!



YOUR custom-made profiles	52
Technical Inquiry	54

YOUR custom-made profiles



BEHAbelt offers you an exclusive and a fast realisation of your desired profile!

Ask our customer support (page 5) for your personal offer.



Tell us about your application!

FAST REALISATION (4-8 WEEKS)

- Many years of experience, in-house manufacturing of tooling, individual consulting.
- Development of customised profiles.
- Designed specifically for your application.
- According to your design.

ECONOMIC ADVANTAGES

- Exclusiveness/ securing the After Sales Market.
- Material combination.
- Optimisation of your application through the perfect profile.
- Improved service life and functionality.
- Appropriate welding technology

NOTE

For special profiles there is always a minimum order quantity and possibly tooling costs required.

We conveying solutions

Our in-house tool manufacturing

Our responsible project management

Our manufacturing expertise

YOUR IDEA

Our product quality

Our strong cooperation with Suppliers and universities

Our technical support

Thanks to our in-house tool manufacturing shop with state-of-the-art equipment, we are able to produce custom profiles for you with extremely short lead times in order to meet your needs.

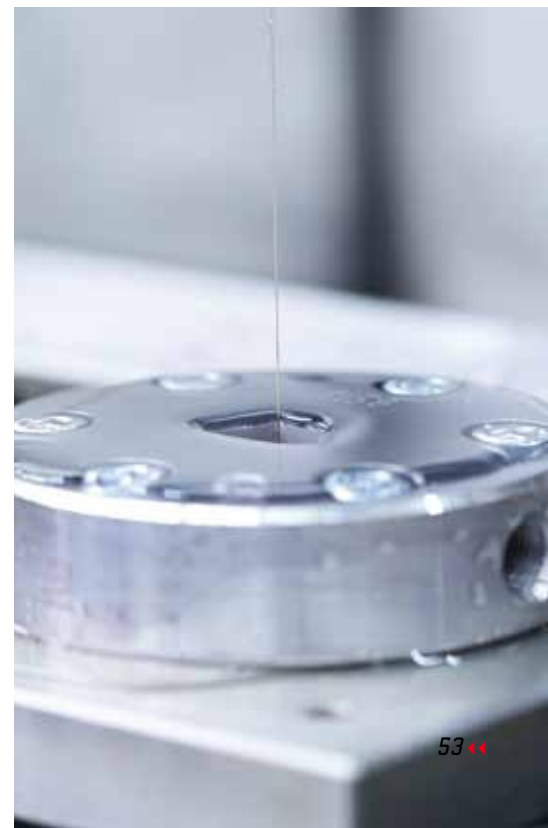

Technical Inquiry

Project		Phone	
Name		E-mail	
Address			

<input type="checkbox"/>	A	I'm looking for a replacement of an existing product. What performance would you like to improve:
<input type="checkbox"/>	B	I'm looking for a technical design support.

PLEASE SEND TO:

Fax: +49 (0) 7684 / 907-101

E-mail: tech@behabelt.com

A

Basic information
for your inquiry

Product description (belt)	
Belt type, shape, size	
Hardness (Shore A or D)	
Type of surface	<input type="checkbox"/> smooth <input type="checkbox"/> matt <input type="checkbox"/> rough <input type="checkbox"/> textured <input type="checkbox"/> other:
Color	
Special product properties (FDA/EC, antistatic, UV, etc.)	
Supply of sample	<input type="checkbox"/> yes <input type="checkbox"/> no
Others	your sketch

B

Basic information
for your inquiry

Process description (conveyor)	
What is being done in the process?	
What products are being transported?	
What are the handled product properties?	
What happens before this process?	
What happens after this process?	
Conveyor layout	
Pulley diameters	Center distance / belt length
Wrap angle	Belt speed
Support or guide of belt	tensioning device/ take up amount <input type="checkbox"/> yes, inch, <input type="checkbox"/> no
Max. belt load	numbers of belts that convey the load
Environmental conditions	
What chemical requirements must the belt withstand?	
What is your cleaning procedure?	
Humidity / water	<input type="checkbox"/> normal <input type="checkbox"/> high <input type="checkbox"/> Belt in water UV-radiation <input type="checkbox"/> yes <input type="checkbox"/> no
Is your belt subject to high abrasion?	<input type="checkbox"/> yes, due to: <input type="checkbox"/> no
Environmental temperature (°C/°F)	Others
Needs assessment	
Order quantity (ft/pc.)	Annual requirement (ft/pc.)
Target Price	Standard coil length (ft)
Packaging / coil form	<input type="checkbox"/> Wooden reel <input type="checkbox"/> Coil <input type="checkbox"/> Box <input type="checkbox"/> Cut to length <input type="checkbox"/> Special winding

This form (including explanatory notes) is also available online at: www.behabelt.com/techinfo

We are happy to advise you by phone: +49 (0) 7684/907-0

© 2/2014 · BEHA Innovation GmbH · In den Engematten 16 · D-79286 Glottertal/Germany

Express Service Fabrication	56
Connection methods for profiles	57
Connection methods for elastic flat belts	57
Mechanical connections	58
Twisted round belts	58
Belt fastener for V-belts	58
Self-Knot connection method for reinforced round belts	59
Fitting connectors for hollow round belts	59
Pliers for fitting connectors	59

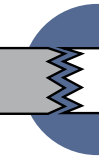

Express Service Fabrication



Our customers not only require belts by roll but also endless joined belts. This is why BEHAbelt offers “Express Service”

Note: information on how to calculate a belt length for tailoring please refer to page 105

Versatile

V- and Round and custom belt profiles in a variety of lengths and diameters and different Shore hardnesses.

Welding of all belt geometries and coated belts!

Flexible

When we designed the machines of our tailoring shop our goal was to being able to fabricate both small and big quantities at attractive cost and to ensure delivery of orders within a couple of days only - we optimized machine set-up times and lead times.

Automated

An automated welding process ensures consistent quality.



Connection methods: Profiles

Standard & extra strong

Regardless of whether you are using unreinforced belts or reinforced belts, we distinguish the following connection methods: butt and overlap welding.

Two connection methods can be used on profiles with reinforcement. Butt welding to reduce elongation without changing the belt strength. Overlap welding to reduce elongation and increase the belt strength.

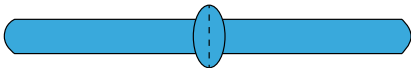

Butt welding without reinforcement (standard)

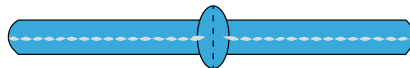

Butt welding with reinforcement (Standard)

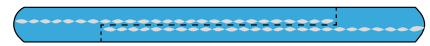

Overlap welding with reinforcement (strong adhesion)

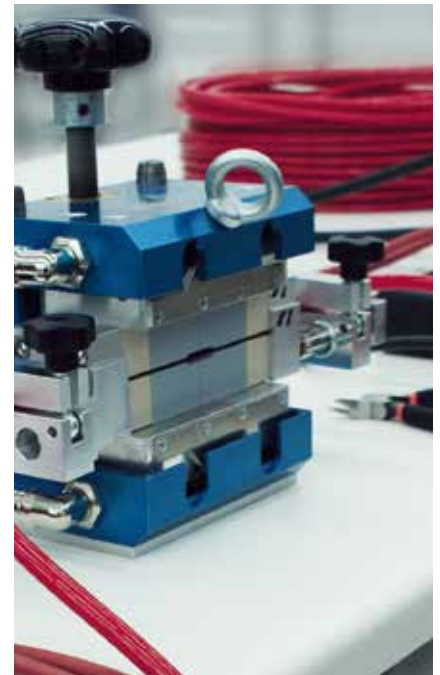

Connection methods for elastic flat belts

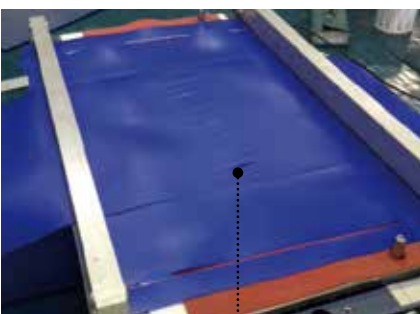

Finger-joint hot press (standard)

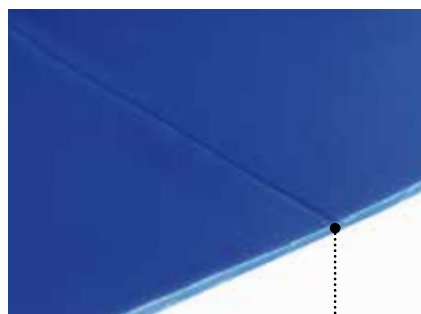

Butt welding hot paddle (endwise)

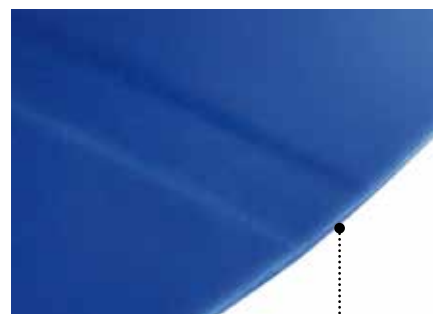

Butt welding hot press (neo)

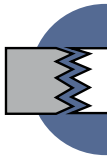

Mechanical connections

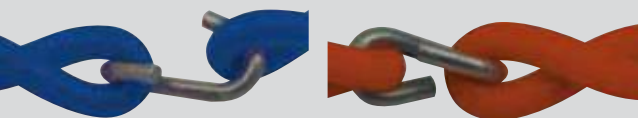

Construction: 2 x \varnothing 3 mm (\varnothing 5 mm)

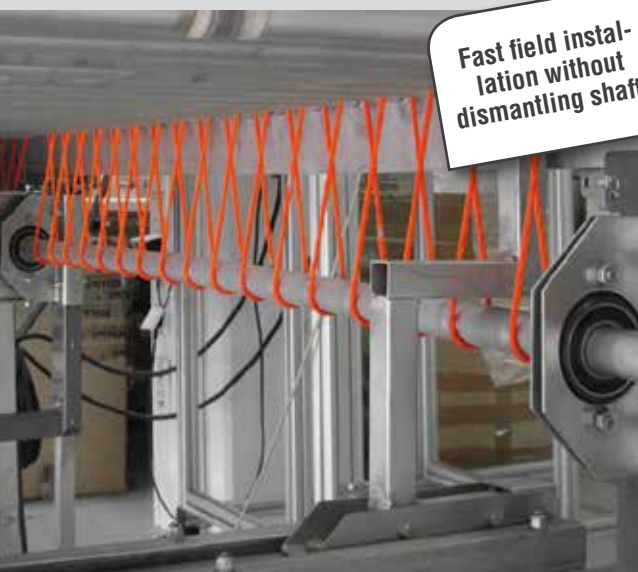

Fast field installation without dismantling shafts

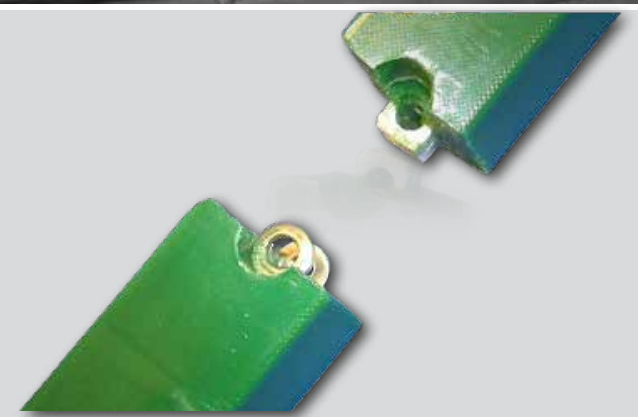

Belt fastener for V-belts

Description
Belt fastener

Order No.
On request

Twisted round belts

Twisted PU round belts, also called “quick connect belts”, are the perfect solution for roller conveyor Systems where more than one belt is sitting on a shaft (called vertical drive). Twisted belts are mounted with the hook open, which then is being closed with pliers once the belt is sitting in the right place.

Advantage

No costly and time consuming dismantling of shafts needed when installing or replacing a belt (short breakdown times).

Product	PU 70 A		PU 75 A PLUS	
Shore	76 A		80 A	
Colour	sky blue		orange	
FDA/EC	yes, smooth		no, smooth (rough)	
CoF (Steel) - μ	approx.. 0,75		approx.. 0,70	
Pretension	8-10%		6-8%	

Diameter	Pulley Diameter	Fmax/ belt*		Pulley Diameter	Fmax/ belt*	
mm	mm	daN	lbs	mm	daN	lbs
\varnothing 5,0	40	2,6	5,8	40	5,9	13,0

Order No.: FBXH3X250LG...FBXH3X450LG Order No.: FBX13X2500G...FBX13X4500G

Available standard lengths of 250-710 mm

* = coefficient of friction μ :0,5



Measure the correct belt length tip to tip (production length LF), without the hook

Belt fastener for reinforced V- and Round belts

Mechanical rotating joint for V- and Round belts which are connected with screws.

A mechanical hinge is embedded in the belt and connected to the reinforcement.

Thanks to the mechanical connection, the belt can be installed and removed quickly, saving valuable time in the production process.

Reinforced Round belt for Self-Knot

This innovative joining method makes it possible to create a quick and cost-effective connection for reinforced round belts.

Description

- Based on a special belt (8mm and up) with loose reinforcement (not bonded with PU).
- The round belt is available by the metre and can be cut to custom lengths.
- Joining itself can be performed on site
- After joining, the belt needs to be butt-welded and is then completely closed again.

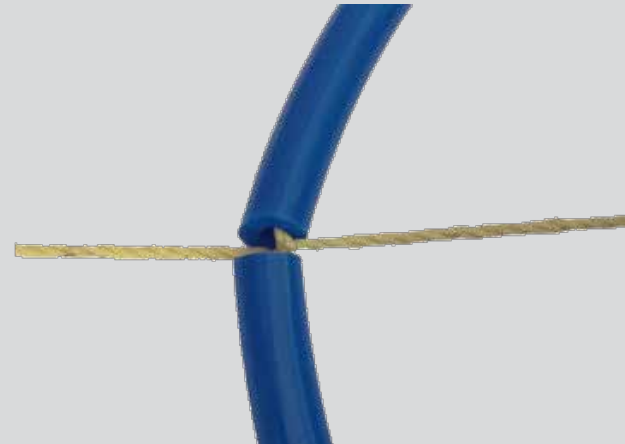

Self-connection

Description
Self-connection

Order No.
On request

Fitting connectors for hollow round belts

Fitting connectors for quick repairs

Hollow round belts should be welded just like solid belts. In the case of a breakdown, fitting connectors can be used for a quick repair, until the belt can be welded once again. Another advantage is the flexibility of the belt for small pulley diameters. The hollow round belts can be connected via metal connectors, as shown in the picture.

Hollow round belts with connectors can also be used in many applications when the belts are not subject to heavy loads or high speeds. In these cases this type of joining represents a good alternative to the welded joint (Make sure that the minimum pulley diameter and the pulley form are correct.) When applying the metal nipple, special care has to be taken not to damage the belt with the sharp metal edges. This would reduce the tensile strength of the joint. Therefore we recommend the use of pointed pliers.

ATTENTION: Be sure to wear gloves to press fit the metal fitting connector. Risk of injury!

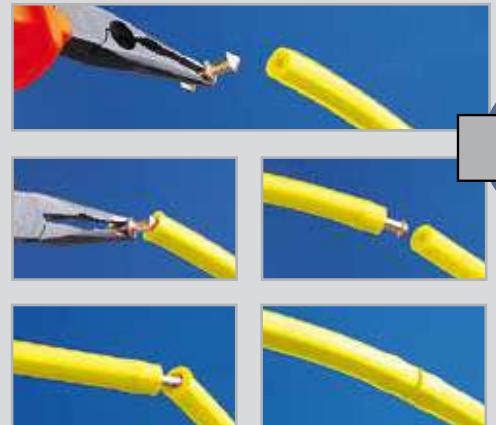

Order No.	For hollow round belts (outer -∅)	
	mm	inch
FBN048	4,8	3/16
FBN063	6,3	1/4
FBN080N	8,0	5/16
FBN095	9,5	3/8
FBN125	12,5	1/2
FBN150	15,0	19/32



Brass fitting

Pliers for fitting connectors



Pliers SZ01

Pliers SZ01 for inserting fasteners in hollow round belts.

Description
Pliers SZ01

Order No.
FBWSZ01



ELASTIC CONVEYOR BELTS & TRACKING PROFILES

The high quality elastic flat belts by BEHAbelt complete the standard BEHAbelt product portfolio and meet the requirements for food contact.

The FDA/EC conformant flat belts are characterised by their particularly high durability in wet areas as well as very good hydrolysis resistance and resistance to microbes.

Elastic conveyor belts up to 700mm	62
PU flat belts as top covers	66
Elastic flat belts 140mm.....	68
V-guides.....	69
Belt edges	70
Cleats.....	71
PU flex sidewalls.....	73



Elastic conveyor belts up to 700 mm

Elastic conveyor belts (100% PU)

replace fabric-reinforced conveyor belts with sealed belt edges.

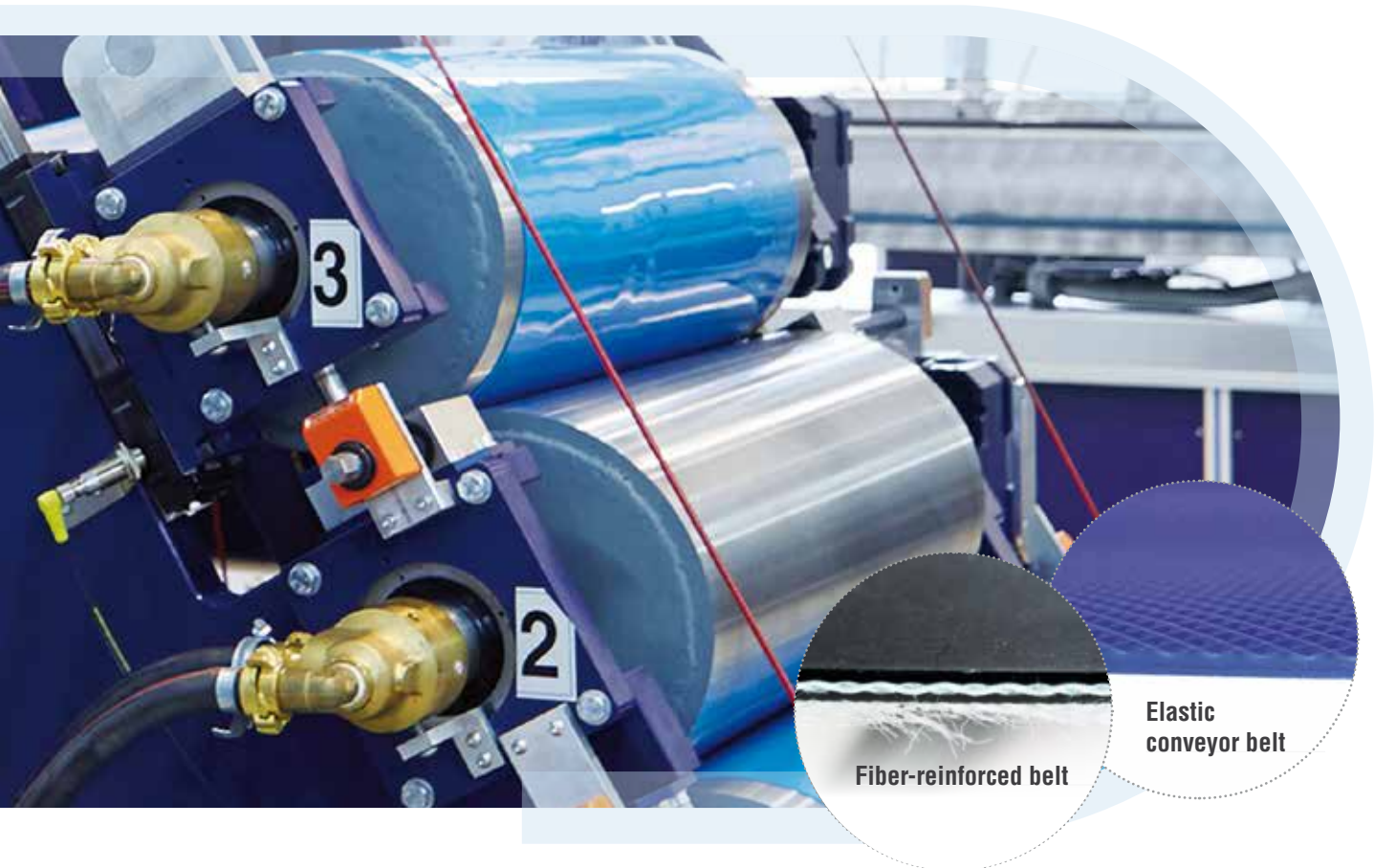

There are several reasons for our homogeneous conveyor belts

- Easily cut to your required belt width.
- Smooth surfaces eliminate any crevices where bacteria may harbour
- No exposed fabrics or seams which can fray.
- Belt is homogeneous so eliminates any chance of ply separation.
- Easy and quick cleaning on site possible.
- Heavily reduced consumption of water and chemicals for daily cleaning.
- Easy belt installation and repair on-site possible.
- Easy joining and excellent weldability.
- High resistance against water, oil and many chemicals.
- High cut and abrasion resistance.
- FDA/EC compliant product line as well as detectable type (for metal detectors in food production lines).

Main areas of application

- Food industry
- Pharmaceutical industry
- Packaging industry



All advantages of our homogeneous BEHAbelt conveyor belts at a glance

Cleanliness

The smooth surface does not offer any crevices where bacteria can harbour. The easy belt cleaning reduces the maintenance costs by:

- low water and cleaning detergent consumption
- low cost for fumigation
- reduced production downtime

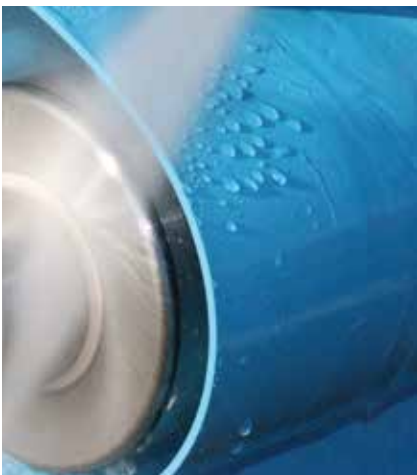

Our belts for the food industry are very hygienic due to their homogeneous material properties and smooth surfaces. This is also the reason for the excellent humidity repelling property of our belts.

FDA / EC compliant

BEHAbelt conveyor belts can be used throughout the food industry – for transport as well as in the processing area with direct food contact. Our food industry belts comply with the requirements of the latest international standards regarding direct contact of food with plastics (FDA/EC) and therefore offer you the perfect solution for your HACCP concept.

Durability

BEHAbelt conveyor belts are very words are OK but no spacing between them! There are no plies to separate. A further advantage is that if damage occurs, the belt can be spot repaired and the entire belt does not need to be replaced.

When selecting the materials for manufacturing our conveyor belts we refer to our proven materials having a very high abrasion resistance.

Cut and abrasion resistance

BEHAbelt conveyor belts are highly resistant to cutting, puncturing and potential further tearing of the belt at the cut location.

Due to the elastic design of the belt, there is no possibility of the belt opening to a fabric layer and thus separation of the belt layers.

Another advantage is that if the belt is cut or punctured, the damaged section can typically be repaired within minutes instead of having to replace the entire belt.

When it comes to selecting the materials we use to manufacture our conveyor belts, we draw on our proven raw materials which offer a very high abrasion resistance.

Individuality/ Welded-on products

The homogeneous feature of BEHAbelt flat belts enables you to easily cut the belts into the desired width.

Even making a wider belt is possible by joining the belts lengthwise with the help of a hot air gun (electrode). This helps you to keep your remnants low. BEHAbelt flat belts can be easily fabricated with our belt accessories such as sidewalls, cleats, V-guides and other profiles and offer reliable and long-lasting operation due to their excellent weldability.

Versatility

The BEHAbelt flat belts are currently available in the hardness range of Shore 74A to 55D. This wide range of different hardness, flexibility and grip makes it possible to meet the various customer specific requirements.

Easy and fast repair

If a belt is punctured or torn you can easily repair it after thorough cleaning by welding it with an electrode. The strength of the belt will not be reduced in this area! For a larger damaged area a replacement patch can be quickly welded in to repair the damage. The repairs are quick and easy and make the belt ready for operation again in a very short time.

Easy installation

The installation is very easy. Welding of your belt on-site can be quickly done with a paddle welding tool or a hot air gun (using an electrode).

For most belt widths one technician is sufficient to safely operate the tools. Our flat belts are ideally suited for joining with standard joining tools such as paddle welding or hot air gun with electrode. In the shop you can also use vulcanizing presses.

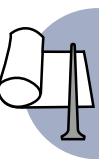

Elastic conveyor belts up to 700 mm

Available surfaces (top sides)



Spikes (SP) (1.6 mm and up)

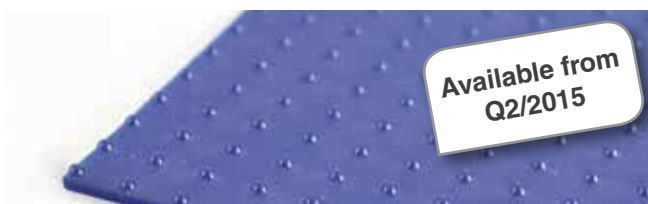

Nipples (NP) (1.6 mm and up)



Inverted diamond (ID) (1.6 mm and up)



Smooth gloss (SG)



Smooth matt (SM)

Available Bottom sides



Smooth gloss (SG)



Fabric impression (FI)

Quality	Colour		Shore-hardness	Belt thickness		Weight* per Meter approx. kg	Recommended Min.-Pulley-Ø		Pull force for pretension of 1%		Standard Roll		
				mm	inch		mm	inch	kg/cm	lbs/inch	m	ft	
PU 65 A	transparent	sapphire blue	72 A	1,6	1/16	1,35	10	0,40	0,16	0,90	50	164	
				2,0	5/64	1,70	12	0,50	0,20	1,10	50	164	
				3,0	1/8	2,50	20	0,80	0,30	1,70	50	164	
PU 75 A	ultramarine blue	white	80 A	1,0	2/50	0,85	10	0,40	0,15	0,85	50	164	
				1,6	1/16	1,35	15	0,60	0,24	1,30	50	164	
				2,0	5/64	1,70	20	0,80	0,30	1,70	50	164	
				3,0	1/8	2,50	30	1,20	0,45	2,50	50	164	
PU 80 A	ultramarine blue	white	84 A	1,0	2/50	0,85	10	0,40	0,20	1,10	50	164	
				1,6	1/16	1,35	15	0,60	0,32	1,80	50	164	
				2,0	5/64	1,70	20	0,80	0,40	2,25	50	164	
				3,0	1/8	2,50	30	1,20	0,60	3,35	50	164	
PU 80 A SAFE	capri blue		84 A	1,0	2/50	1,35	10	0,40	0,18	1,00	50	164	
				1,6	1/16	1,70	15	0,60	0,29	1,60	50	164	
				2,0	5/64	2,50	20	0,80	0,36	2,00	50	164	
PU 95 A	sky blue	ultramarine blue	white	95 A	1,6	1/16	1,35	25	1,00	0,80	4,50	50	164
					2,0	5/64	1,70	35	1,40	1,00	5,60	50	164
					3,0	1/8	2,50	50	2,00	1,50	8,40	50	164
TPE 55 D	sky blue	ultramarine blue	white	55 D	2,0	5/64	1,70	65	2,60	1,50	8,40	50	164
					3,0	1/8	2,50	85	3,40	2,25	12,60	50	164

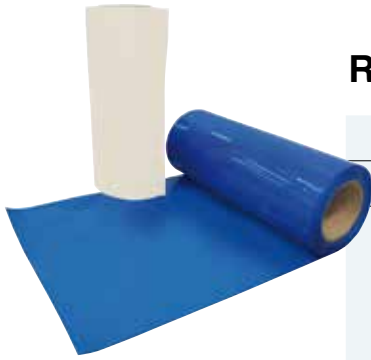

Recommended pretension for elastic belts

			max. Belt width									
			< 50 mm		< 100 mm		< 200 mm		< 400 mm		< 700 mm	
Quality	Shore	Profile thickness (mm)	Recommended pretension	applied pretension force = bearing load	Recommended pretension	applied pretension force = bearing load	Recommended pretension	applied pretension force = bearing load	Recommended pretension	applied pretension force = bearing load	Recommended pretension	applied pretension force = bearing load
			%	N	%	N	%	N	%	N	%	N
PU 65 A	72 A	1,6	4...5	64...80	3...5	96...160	3...5	192...320	1,5...5	192- 640	0,7...5	156...1120
		2,0	4...5	80... 100	3...5	120...200	2...5	160...400	1...5	160...800	0,7...5	196...1400
		3,0	4...5	120...150	3...5	100...300	1,5...5	180...600	0,7...5	168...1200	0,5...5	210...2100
PU 75 A	80 A	1,0	4...5	60...75	3...5	90...150	3...5	180...300	1,5...5	180...600	0,7...5	147...1050
		1,6	4...5	96...120	3...5	144...240	1,5...5	144...480	1...5	192...960	0,5...5	168...1680
		2,0	4...5	120...150	3...5	180...300	1,5...5	180...600	0,7...5	168...1200	0,5...5	210...2100
		3,0	4...5	180...225	2...5	180...450	1...5	180...900	0,5...5	180...1800	0,5...5	315...3150
PU 80 A	84 A	1,0	4...5	80...100	3...5	120...200	2...5	160...400	1...5	160...800	0,7...5	196...1400
		1,6	4...5	128...160	3...5	192...320	1,5...5	192...640	0,7...5	180...1280	0,5...5	224...2240
		2,0	4...5	160...200	2...5	160...400	1...5	160...800	0,5...5	160...1600	0,5...5	280...2800
		3,0	3...5	180...300	1,5...5	180...600	0,7...5	168...1200	0,5...5	240...2400	0,5...5	420...4200
PU 80 A SAFE	84 A	1,0	4...5	72...90	3...5	108...180	2...5	144...360	1...5	144...720	0,7...5	175...1260
		1,6	4...5	116...145	3...5	174...290	1,5...5	174...580	1...5	232...1160	0,5...5	203...2030
		2,0	4...5	144...180	2...5	144...360	1...5	144...720	0,5...5	144...1440	0,5...5	252...2520
PU 95 A	95 A	1,6	2...3	160...240	1...3	160...480	0,5...3	160...960	0,5...3	320...1920	0,5...3	560...3360
		2,0	1,5...3	150...300	1...3	200...600	0,5...3	200...1200	0,5...3	400...2400	0,5...3	700...4200
		3,0	1...3	150...450	0,5...3	150...900	0,5...3	300...1800	0,5...3	600...3600	0,5...3	1050...6300
TPE 55 D	55 D	2,0	1...3	200...600	0,5...3	200...1200	0,5...3	400...2400	0,5...3	800...3600	0,5...3	1400...6300
		3,0	0,5...3	150...900	0,5...3	300...1800	0,5...3	600...3600	0,5...3	1200...5400	0,5...3	2100...9450



Coefficient of friction μ for belt surfaces on steel

Quality	Smooth gloss (G)	Smooth matt (MT)	Fabric impression (FI)	Inverted diamond (ID)
PU 65 A	0,85	0,80	0,70	0,65
PU 75 A	0,70	0,65	0,55	0,50
PU 80 A	0,65	0,60	0,50	0,45
PU 95 A	0,45	0,40	0,30	0,25
TPE 55 D	0,35	0,30	0,25	0,20

PU-flat belts as coating



BEHAbelt Putex

Similar to a rubber coating, but fully weldable and offers excellent properties against delamination of the coating.

The unique BEHAbelt PU compound combines excellent grip properties due to the high coefficient of friction with simultaneously low abrasion.

BEHAbelt PUtex is the perfect alternative to rubber.



approx. 65° Shore A

PUTex red



Order No.	Belt thickness		max. Belt width		approx. Weight* kg/100m	Standard Roll		Impact on min. pulley-Ø	
	mm	inch	mm	inch		m	(ft)	mm	inch
FBFF150X16BM	1,6	1/16	140	5,5	25,2	50	(164)	+ 15,0	+ 0,6
FBFF150X2BM	2,0	5/64	140	5,5	31,5	50	(164)	+ 20,0	+ 0,8
FBFF150X3BM	3,0	1/8	140	5,5	47,3	50	(164)	+ 30,0	+ 1,2
FBFF150X4BM	4,0	5/32	140	5,5	63,0	50	(164)	+ 40,0	+ 1,6

Coefficient of friction μ : Steel: approx. 0,90 | PE: approx. 0,55 | HDPE: approx. 0,50 | FDA/EC compliant

* Band width 140mm



approx. 65° Shore A

PU 60 A transparent smooth



Order No.	Belt thickness		max. Belt width		approx. Weight* kg/100m	Standard Roll		Impact on min. pulley-Ø	
	mm	inch	mm	inch		m	(ft)	mm	inch
FBFF150X16TG	1,6	1/16	140	5,5	28,8	50	(164)	+ 15,0	+ 0,6
FBFF150X2TG	2,0	5/64	140	5,5	36,0	50	(164)	+ 20,0	+ 0,8
FBFF150X3TG	3,0	1/8	140	5,5	54,0	50	(164)	+ 30,0	+ 1,2
FBFF150X4TG	4,0	5/32	140	5,5	72,0	50	(164)	+ 40,0	+ 1,6

Coefficient of friction μ : Steel: approx. 0,90 | PE: approx. 0,55 | HDPE: approx. 0,50 | FDA/EC compliant

* Band width 140mm



approx. 72° Shore A

PU 65 A transparent smooth



Order No.	Belt thickness		max. Belt width		approx. Weight* kg/100m	Standard Roll		Impact on min. pulley-Ø	
	mm	inch	mm	inch		m	(ft)	mm	inch
FBFG150X1TG	1,0	3/64	140	5,5	18,0	50	(164)	+ 10,0	+ 0,4
FBFG150X16TG	1,6	1/16	140	5,5	28,8	50	(164)	+ 15,0	+ 0,6
FBFG150X2TG	2,0	5/64	140	5,5	36,0	50	(164)	+ 20,0	+ 0,8
FBFG150X3TG	3,0	1/8	140	5,5	54,0	50	(164)	+ 30,0	+ 1,2
FBFG150X4TG	4,0	5/32	140	5,5	72,0	50	(164)	+ 40,0	+ 1,6

Coefficient of friction μ : Steel: approx. 0,85 | PE: approx. 0,5 | HDPE: approx. 0,45 | FDA/EC/USDA compliant

* Band width 140mm



BEHAbelt top covers

We offer a variety of transparent polyurethane coatings with outstanding welding characteristics.

In addition, all coatings are FDA / EC compliant and thus offer a wide range of applications.

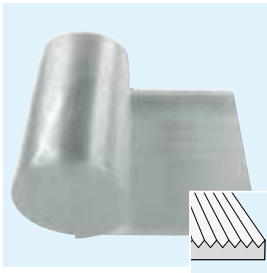

PU 65 A transparent, surface ribbed**



Order No.	Belt thickness		max. Belt width		approx. Weight* kg/100m	Standard Roll		Impact on min. pulley-∅	
	mm	inch	mm	inch		m	(ft)	mm	inch
FBFG150X26TW	2,6	1/10	140	5,5	46,8	50	(164)	+ 25,0	+ 1,0
FBFG150X3TW	3,0	1/8	140	5,5	54,0	50	(164)	+ 30,0	+ 1,2

** Rib shape according to DIN 7867/ISO 9982

approx. 72° Shore A

Coefficient of friction μ : Steel: approx. 0,85 | PE: approx. 0,50 | HDPE: approx. 0,45 | FDA/EC/USDA compliant

* Band width 140mm



PU 75 A transparent smooth



Order No.	Belt thickness		max. Belt width		approx. Weight* kg/100m	Standard Roll		Impact on min. pulley-∅	
	mm	inch	mm	inch		m	(ft)	mm	inch
FBFI150X1TG	1,0	3/64	140	5,5	18,0	50	(164)	+ 15,0	+ 0,6
FBFI150X16TG	1,6	1/16	140	5,5	28,8	50	(164)	+ 20,0	+ 0,8
FBFI150X2TG	2,0	5/64	140	5,5	36,0	50	(164)	+ 25,0	+ 1,0
FBFI150X3TG	3,0	1/8	140	5,5	54,0	50	(164)	+ 40,0	+ 1,6
FBFI150X4TG	4,0	5/32	140	5,5	72,0	50	(164)	+ 50,0	+ 2,0

approx. 80° Shore A

Coefficient of friction μ : Steel: approx. 0,70 | PE: approx. 0,40 | HDPE: approx. 0,35 | FDA/EC/USDA compliant

* Band width 140mm



PU 85 A transparent smooth



Order No.	Belt thickness		max. Belt width		approx. Weight* kg/100m	Standard Roll		Impact on min. pulley-∅	
	mm	inch	mm	inch		m	(ft)	mm	inch
FBFK150X1TG	1,0	3/64	140	5,5	18,0	50	(164)	+ 20,0	+ 0,8
FBFK150X16TG	1,6	1/16	140	5,5	28,8	50	(164)	+ 30,0	+ 1,2
FBFK150X2TG	2,0	5/64	140	5,5	36,0	50	(164)	+ 40,0	+ 1,6
FBFK150X3TG	3,0	1/8	140	5,5	54,0	50	(164)	+ 50,0	+ 2,0
FBFK150X4TG	4,0	5/32	140	5,5	72,0	50	(164)	+ 70,0	+ 2,7

approx. 88° Shore A

Coefficient of friction μ : Steel: approx. 0,60 | PE: approx. 0,35 | HDPE: approx. 0,30 | FDA/EC/USDA compliant

* Band width 140mm

Elastic flat belts 140 mm

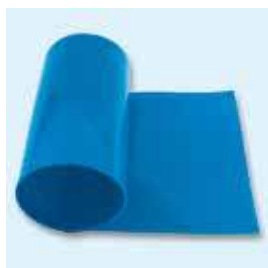

approx. 80° Shore A

Recommended pretension
1...5 %

PU 75 A sky blue smooth



Order No.	Profile thickness		max. Belt width		approx. Weight* kg/100m	Standard Roll		Recommended Min. pulley Ø		Pull force for pretension of 1%	
	mm	inch	mm	inch		m	(ft)	mm	inch	kg/cm	lbs/inch
FBFI150X1LG	1,0	3/64	140	5,5	18,0	50	(164)	10,0	0,4	0,15	0,85
FBFI150X16LG	1,6	1/16	140	5,5	28,8	50	(164)	15,0	0,6	0,24	1,3
FBFI150X2LG	2,0	5/64	140	5,5	36,0	50	(164)	20,0	0,8	0,30	1,7
FBFI150X3LG	3,0	1/8	140	5,5	54,0	50	(164)	25,0	1	0,45	2,5
FBFI150X4LG	4,0	5/32	140	5,5	72,0	50	(164)	35,0	1,4	0,60	3,4

Coefficient of friction μ : Steel: approx. 0,70 | PE: approx. 0,40 | HDPE: approx. 0,35 | FDA/EC compliant

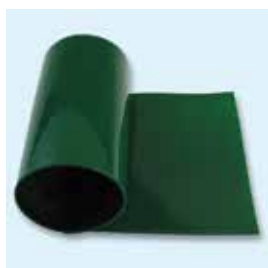

approx. 88° Shore A

Recommended pretension
1...5 %

PU 85 A green smooth

Order No.	Profile thickness		max. Belt width		approx. Weight* kg/100m	Standard Roll		Recommended Min. pulley Ø		Pull force for pretension of 1%	
	mm	inch	mm	inch		m	(ft)	mm	inch	kg/cm	lbs/inch
FBFK150X1GG	1,0	3/64	140	5,5	18,0	50	(164)	15,0	0,6	0,23	1,3
FBFK150X16GG	1,6	1/16	140	5,5	28,8	50	(164)	20,0	0,8	0,37	2,1
FBFK150X2GG	2,0	5/64	140	5,5	36,0	50	(164)	30,0	1,2	0,46	2,6
FBFK150X3GG	3,0	1/8	140	5,5	54,0	50	(164)	35,0	1,4	0,69	3,9
FBFK150X4GG	4,0	5/32	140	5,5	72,0	50	(164)	45,0	1,8	0,92	5,2

Coefficient of friction μ : Steel: approx. 0,60 | PE: approx. 0,35 | HDPE: approx. 0,30

Ready-made belts



approx. 84° Shore A

Recommended pretension
1...5 %

PU 80 A orange smooth



Order No.	Profile thickness		max. Belt width		approx. Weight kg/Gebinde	Standard Roll		Recommended Min. pulley Ø		Pull force for pretension of 1%	
	mm	inch	mm	inch		ft	(m)	mm	inch	kg/cm	lbs/inch
FBFJOG1	1,6	1/16	12,5	1/2	0,7	100	(30,48)	15	0,6	0,32	1,8
FBFJOG2	1,6	1/16	19	3/4	1,1	100	(30,48)	15	0,6	0,32	1,8
FBFJOG3	1,6	1/16	38	1 1/2	2,2	100	(30,48)	15	0,6	0,32	1,8
FBFJOG4	1,6	1/16	44	1 3/4	2,6	100	(30,48)	15	0,6	0,32	1,8
FBFJOG5	1,6	1/16	50	2	2,9	100	(30,48)	15	0,6	0,32	1,8
FBFJOG6	1,6	1/16	76	3	4,4	100	(30,48)	15	0,6	0,32	1,8
FBFJOG7	2,4	3/32	25	1	2,2	100	(30,48)	20	0,8	0,48	2,7
FBFJOG8	2,4	3/32	32	1 1/4	2,8	100	(30,48)	20	0,8	0,48	2,7
FBFJOG9	2,4	3/32	38	1 1/2	3,3	100	(30,48)	20	0,8	0,48	2,7
FBFJOG10	2,4	3/32	50	2	4,4	100	(30,48)	20	0,8	0,48	2,7
FBFJOG11	3,2	1/8	16	1/8	1,9	100	(30,48)	25	1,0	0,64	3,6
FBFJOG12	3,2	1/8	25	1	2,9	100	(30,48)	25	1,0	0,64	3,6

Coefficient of friction μ : Steel: approx. 0,65 | PE: approx. 0,35 | HDPE: approx. 0,3 | FDA/EC/USDA compliant

Cut-to-width up to 140mm possible, please contact us!

BEHAbelt offers a broad range of guiding profiles to assist in tracking your conveyor belt.

Advantages:

- All profiles are made from PU and can be supplied in various colours upon request.
- Approved for use in food contact applications in conformance with FDA, EC
- Excellent bonding to PU or PVC belts with hot air or high frequency welding (PU 70 A).



PU 60 A transparent smooth, V-Guide

Order No.	Profile dimension mm	Cross Section cm ²	approx. Weight kg/100 m	Standard Roll		Recommended Min. pulley \varnothing	
				m	(ft)	mm	inch
FBKF6YTG	6 x 4 (Y)	0,19	2,3	150	(492)	25,0	1,0
FBKF8MTG	8 x 5 (M)	0,32	4	150	(492)	30,0	1,2
FBKF10ZTG	10 x 6 (Z)	0,48	6	150	(492)	40,0	1,6
FBKF13ATG	13 x 8 (A)	0,82	10	150	(492)	60,0	2,4
FBKF17BTG	17 x 11 (B)	1,46	18	100	(328)	80,0	3,2
FBKF22CTG	22 x 14 (C)	2,40	29	50	(164)	110,0	4,4

approx. 65° Shore A

Coefficient of friction μ : Steel: approx. 0,85 | PE: approx. 0,50 | HDPE: approx. 0,45



PU 70 A transparent smooth, V-Guide



Order No.	Profile dimension mm	Cross Section cm ²	approx. Weight kg/100 m	Standard Roll		Recommended Min. pulley \varnothing	
				m	(ft)	mm	inch
FBKH6YTG	6 x 4 (Y)	0,19	2,3	150	(492)	30,0	1,2
FBKH8MTG	8 x 5 (M)	0,32	4	150	(492)	35,0	1,4
FBKH10ZTG	10 x 6 (Z)	0,48	6	150	(492)	45,0	1,8
FBKH13ATG	13 x 8 (A)	0,82	10	150	(492)	70,0	2,8
FBKH17BTG	17 x 11 (B)	1,46	18	100	(328)	90,0	3,6
FBKH22CTG	22 x 14 (C)	2,40	29	50	(164)	130,0	5,2

approx. 76° Shore A

Coefficient of friction μ : Steel: approx. 0,75 | PE: approx. 0,40 | HDPE: approx. 0,35 | FDA/EC/USDA compliant

SAFE

Metal detectable

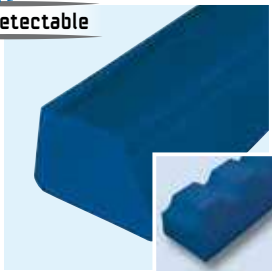

PU 70 A SAFE capri blue smooth, V-Guide



Order No.	Profile dimension mm	Cross Section cm ²	approx. Weight kg/100 m	Standard Roll		Recommended Min. pulley \varnothing	
				m	(ft)	mm	inch
FBKF6YLGA	6 x 4 (Y)	0,19	2,3	150	(492)	30,0	1,2
FBKF8MLGA	8 x 5 (M)	0,32	4	150	(492)	35,0	1,4
FBKF10ZLGA	10 x 6 (Z)	0,48	6	150	(492)	45,0	1,8
FBKF13ALGA	13 x 8 (A)	0,82	10	150	(492)	70,0	2,8
FBKF17BLGA	17 x 11 (B)	1,46	18	100	(328)	90,0	3,6
FBKF22CLGA	22 x 14 (C)	2,40	29	50	(164)	130,0	5,2

approx. 76° Shore A

Coefficient of friction μ : Steel: approx. 0,75 | PE: approx. 0,40 | HDPE: approx. 0,35 | FDA/EC/USDA compliant

All V-Guides in notched version on request

BEHAbelt belt edges

For stabilizing and guiding curved belts so called belt edges are used. In most case the profiles are stitched or glued on the curved belt. Through the profile bead the curved belt can be supported on the edges when running.

Advantages:

- High tear resistance
- High flexibility
- Low abrasion
- Individual colours possible

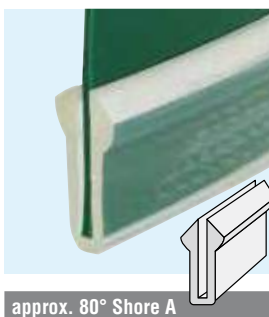

Belt edge 13 x 26 mm, transparent

Order No.	Profile dimension	Cross Section	approx. Weight	Standard Roll	
	mm	cm ²	kg/100 m	m	(ft)
FBSP80A13X26	13 x 26	1,49	17,9	30,0	(98,4)

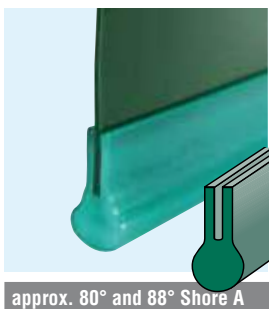

Belt edge 14 x 28 mm, emerald green

Order No.	Profile dimension	Cross Section	approx. Weight	Standard Roll	
	mm	cm ²	kg/100 m	m	ft
FBSP70A14X28	14 x 28	1,9	22,8	30,0	98,4
FBSP85A14X28	14 x 28	1,9	22,8	30,0	98,4

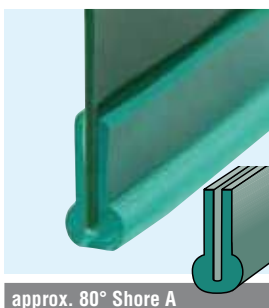

Belt edge 8,8 x 18 mm, emerald green

Order No.	Profile dimension	Cross Section	approx. Weight	Standard Roll	
	mm	cm ²	kg/100 m	m	ft
FBSP80A88X18	8,8 x 18	6,2	7,4	30,0	98,4

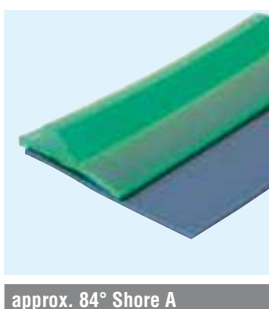

Belt edge 3,5 x 37 mm, emerald green

Order No.	Profile dimension	Cross Section	approx. Weight	Standard Roll	
	mm	cm ²	kg/100 m	m	ft
FBSP80A35X37	3,5 x 37	1,2	14,3	30,0	98,4



Type: feathered foot weldable on PU and PVC belts



approx. 84° Shore A

FDA/EC/USDA compliant

PU 80 A white



Order No.	Height (mm) H	Height (inch) H	Foot width (mm) W	Foot width (inch) W	Weight (g/m)	Standard length per piece (m)	Standard Roll
FBCJ025WUS	25,00	1,00	12,50	0,50	154,00	3,00	80 pcs. = 240m
FBCJ038WUS	38,00	1,50	12,50	0,50	228,00	3,00	50 pcs. = 150m
FBCJ050WUS	50,00	2,00	12,50	0,50	302,00	3,00	40 pcs. = 120m



approx. 84° Shore A

FDA/EC/USDA compliant

PU 80 A green



Order No.	Height (mm) H	Height (inch) H	Foot width (mm) W	Foot width (inch) W	Weight (g/m)	Standard length per piece (m)	Standard Roll
FBCJ025GUS	25,00	1,00	12,50	0,50	154,00	3,00	80 pcs. = 240m
FBCJ038GUS	38,00	1,50	12,50	0,50	228,00	3,00	50 pcs. = 150m
FBCJ050GUS	50,00	2,00	12,50	0,50	302,00	3,00	40 pcs. = 120m



approx. 84° Shore A

FDA/EC/USDA compliant

PU 80 A blue green



Order No.	Height (mm) H	Height (inch) H	Foot width (mm) W	Foot width (inch) W	Weight (g/m)	Standard length per piece (m)	Standard Roll
FBCJ025LGUS	25,00	1,00	12,50	0,50	154,00	3,00	80 pcs. = 240m
FBCJ038LGUS	38,00	1,50	12,50	0,50	228,00	3,00	50 pcs. = 150m
FBCJ050LGUS	50,00	2,00	12,50	0,50	302,00	3,00	40 pcs. = 120m



approx. 84° Shore A

FDA/EC/USDA compliant

PU 80 A sky blue



Order No.	Height (mm) H	Height (inch) H	Foot width (mm) W	Foot width (inch) W	Weight (g/m)	Standard length per piece (m)	Standard Roll
FBCJ025LUS	25,00	1,00	12,50	0,50	154,00	3,00	80 pcs. = 240m
FBCJ038LUS	38,00	1,50	12,50	0,50	228,00	3,00	50 pcs. = 150m
FBCJ050LUS	50,00	2,00	12,50	0,50	302,00	3,00	40 pcs. = 120m

SAFE

Metal detectable



approx. 84° Shore A

FDA/EC/USDA compliant

PU 80 A SAFE capri blue



Order No.	Height (mm) H	Height (inch) H	Foot width (mm) W	Foot width (inch) W	Weight (g/m)	Standard length per piece (m)	Standard Roll
FBCJ025LCUS	25,00	1,00	12,50	0,50	154,00	3,00	80 pcs. = 240m
FBCJ038LCUS	38,00	1,50	12,50	0,50	228,00	3,00	50 pcs. = 150m
FBCJ050LCUS	50,00	2,00	12,50	0,50	302,00	3,00	40 pcs. = 120m

Type: narrow foot weldable on PU belts



approx. 92° Shore A
FDA/EC/USDA compliant

PU 90 A white



Order No.	Height (mm) H	Height (inch) H	Foot width (mm) W	Weight (g/m)	Standard length per piece (m)	Standard Roll
FBCJ020W	20,00	0,79	10,0	75,00	3,0	80 pcs. = 240 m
FBCJ030W	30,00	1,18	10,0	109,00	3,0	60 pcs. = 180 m
FBCJ040W	40,00	1,57	10,0	129,00	3,0	40 pcs. = 120 m
FBCJ050W	50,00	2,00	10,0	235,00	3,0	40 pcs. = 120 m
FBCJ060W	60,00	2,40	10,0	280,00	3,0	30 pcs. = 90 m



approx. 92° Shore A
FDA/EC/USDA compliant

PU 90 A green



Order No.	Height (mm) H	Height (inch) H	Foot width (mm) W	Weight (g/m)	Standard length per piece (m)	Standard Roll
FBCJ020G	20,00	0,79	10,0	75,00	3,0	80 pcs. = 240 m
FBCJ030G	30,00	1,18	10,0	109,00	3,0	60 pcs. = 180 m
FBCJ040G	40,00	1,57	10,0	129,00	3,0	40 pcs. = 120 m
FBCJ050G	50,00	2,00	10,0	235,00	3,0	40 pcs. = 120 m
FBCJ060G	60,00	2,40	10,0	280,00	3,0	30 pcs. = 90 m

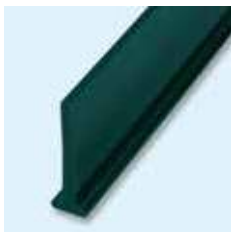

approx. 92° Shore A
FDA/EC/USDA compliant

PU 90 A blue green



Order No.	Height (mm) H	Height (inch) H	Foot width (mm) W	Weight (g/m)	Standard length per piece (m)	Standard Roll
FBCJ020LG	20,00	0,79	10,0	75,00	3,0	80 pcs. = 240 m
FBCJ030LG	30,00	1,18	10,0	109,00	3,0	60 pcs. = 180 m
FBCJ040LG	40,00	1,57	10,0	129,00	3,0	40 pcs. = 120 m
FBCJ050LG	50,00	2,00	10,0	235,00	3,0	40 pcs. = 120 m
FBCJ060LG	60,00	2,40	10,0	280,00	3,0	30 pcs. = 90 m

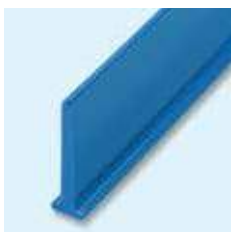

approx. 92° Shore A
FDA/EC/USDA compliant

PU 90 A sky blue



Order No.	Height (mm) H	Height (inch) H	Foot width (mm) W	Weight (g/m)	Standard length per piece (m)	Standard Roll
FBCJ020L	20,00	0,79	10,0	75,00	3,0	80 pcs. = 240 m
FBCJ030L	30,00	1,18	10,0	109,00	3,0	60 pcs. = 180 m
FBCJ040L	40,00	1,57	10,0	129,00	3,0	40 pcs. = 120 m
FBCJ050L	50,00	2,00	10,0	235,00	3,0	40 pcs. = 120 m
FBCJ060L	60,00	2,40	10,0	280,00	3,0	30 pcs. = 90 m

SAFE

Metal detectable

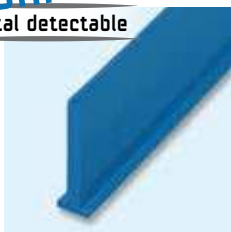

approx. 92° Shore A
FDA/EC/USDA compliant

PU 90 A SAFE capri blue



Order No.	Height (mm) H	Height (inch) H	Foot width (mm) W	Weight (g/m)	Standard length per piece (m)	Standard Roll
FBCJ020LC	20,00	0,79	10,0	75,00	3,0	80 pcs. = 240 m
FBCJ030LC	30,00	1,18	10,0	109,00	3,0	60 pcs. = 180 m
FBCJ040LC	40,00	1,57	10,0	129,00	3,0	40 pcs. = 120 m
FBCJ050LC	50,00	2,00	10,0	235,00	3,0	40 pcs. = 120 m
FBCJ060LC	60,00	2,40	10,0	280,00	3,0	30 pcs. = 90 m



BEHAbelt PU flex sidewalls

The BEHAbelt PU Flex sidewalls for retaining bulk products are available in 2 versions.

- Extremely flexible material with good abrasion and cut resistance
- Very good and easy weldability on PU and PVC belts (using hot air or bonding cement)
- Approved for use in food contact applications in conformance with FDA/EC

Version 1

Flat belt strip without foot for direct welding onto the conveyor belt

Advantages

- No waste since the flat belt strips are offered in pre-cut widths
- Thus no costly storing of remnants or additional costs due to waste

Version 2

Flat belt strip with foot for direct welding onto the conveyor belt

Advantages

- The version with foot allows for particularly small pulley diameters on account of the high degree of undulation of the wave profile

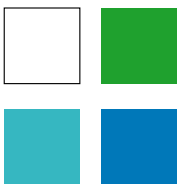

PU 80 A Cut-to-width flat belts for side walls



Order No.	Belt thickness		Belt width		Standard Roll	
	mm	inch	mm	inch	m	ft
on request	2,0	5/64	20	0,8	100	164
on request	2,0	5/64	30	1,2	100	164
on request	2,0	5/64	40	1,6	100	164
on request	2,0	5/64	50	2,0	100	164
on request	2,0	5/64	60	2,4	100	164
on request	2,0	5/64	80	3,2	100	164
on request	2,0	5/64	100	4,0	100	164
on request	2,0	5/64	120	4,8	100	164
on request	2,0	5/64	140	5,5	100	164

approx. 84° Shore A

Coefficient of friction μ : Steel: approx. 0,60 | PE: approx. 0,30 | HDPE: approx. 0,25 | FDA/EC/USDA compliant

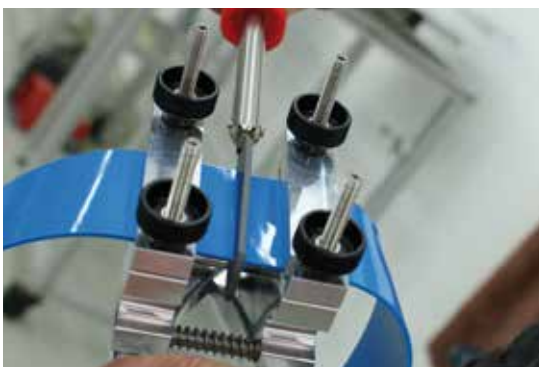

Welding tools for extending the trimmed flat belts

The BEHAbelt FZ02/3F guide clamp in combination with a welding paddle provides a simple method for extending trimmed flat belts. In addition, 100% of the remnants can also be used in this manner.

For more information see page 84.



PU Flex sidewalls



approx. 84° Shore A
FDA/EC/USDA compliant

PU 80 A white



Order No.	Height (mm) H	Height (inch) H	Wave width (mm) B	Base width (mm) B1	Pitch off waves (mm) A	Approx. Weight (g/m)	Standard Roll (m)	Min. pulley diameter Ø (mm)	Recomm. pulley Ø (mm)
FBV FH020W	20,00	0,79	23,00	32,00	25,40	174	100	35	70
FBV FH030W	30,00	1,18	23,00	32,00	25,40	220	100	55	80
FBV FH040W	40,00	1,57	23,00	32,00	25,40	265	100	75	90
FBV FH050W	50,00	1,97	23,00	32,00	25,40	310	100	80	100
FBV FH060W	60,00	2,36	45,00	55,00	50,80	445	100	90	110
FBV FH080W	80,00	3,15	45,00	55,00	50,80	544	100	125	130
FBV FH100W	100,00	3,94	45,00	55,00	50,80	642	100	155	160
FBV FH120W	120,00	4,72	45,00	55,00	50,80	741	50	170	185



approx. 84° Shore A
FDA/EC/USDA compliant

PU 80 A green



Order No.	Height (mm) H	Height (inch) H	Wave width (mm) B	Base width (mm) B1	Pitch off waves (mm) A	Approx. Weight (g/m)	Standard Roll (m)	Min. pulley diameter Ø (mm)	Recomm. pulley Ø (mm)
FBV FH020G	20,00	0,79	23,00	32,00	25,40	174	100	35	70
FBV FH030G	30,00	1,18	23,00	32,00	25,40	220	100	55	80
FBV FH040G	40,00	1,57	23,00	32,00	25,40	265	100	75	90
FBV FH050G	50,00	1,97	23,00	32,00	25,40	310	100	80	100
FBV FH060G	60,00	2,36	45,00	55,00	50,80	445	100	90	110
FBV FH080G	80,00	3,15	45,00	55,00	50,80	544	100	125	130
FBV FH100G	100,00	3,94	45,00	55,00	50,80	642	100	155	160
FBV FH120G	120,00	4,72	45,00	55,00	50,80	741	50	170	185



approx. 84° Shore A
FDA/EC/USDA compliant

PU 80 A sky blue



Order No.	Height (mm) H	Height (inch) H	Wave width (mm) B	Base width (mm) B1	Pitch off waves (mm) A	Approx. Weight (g/m)	Standard Roll (m)	Min. pulley diameter Ø (mm)	Recomm. pulley Ø (mm)
FBV FH020L	20,00	0,79	23,00	32,00	25,40	174	100	35	70
FBV FH030L	30,00	1,18	23,00	32,00	25,40	220	100	55	80
FBV FH040L	40,00	1,57	23,00	32,00	25,40	265	100	75	90
FBV FH050L	50,00	1,97	23,00	32,00	25,40	310	100	80	100
FBV FH060L	60,00	2,36	45,00	55,00	50,80	445	100	90	110
FBV FH080L	80,00	3,15	45,00	55,00	50,80	544	100	125	130
FBV FH100L	100,00	3,94	45,00	55,00	50,80	642	100	155	160
FBV FH120L	120,00	4,72	45,00	55,00	50,80	741	50	170	185

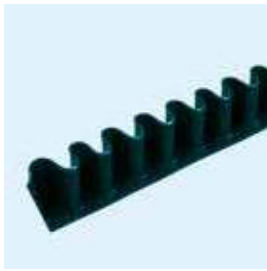

approx. 84° Shore A
FDA/EC/USDA compliant

PU 80 A blue green



Order No.	Height (mm) H	Height (inch) H	Wave width (mm) B	Base width (mm) B1	Pitch off waves (mm) A	Approx. Weight (g/m)	Standard Roll (m)	Min. pulley diameter Ø (mm)	Recomm. pulley Ø (mm)
FBVFH020LG	20,00	0,79	23,00	32,00	25,40	174	100	35	70
FBVFH030LG	30,00	1,18	23,00	32,00	25,40	220	100	55	80
FBVFH040LG	40,00	1,57	23,00	32,00	25,40	265	100	75	90
FBVFH050LG	50,00	1,97	23,00	32,00	25,40	310	100	80	100
FBVFH060LG	60,00	2,36	45,00	55,00	50,80	445	100	90	110
FBVFH080LG	80,00	3,15	45,00	55,00	50,80	544	100	125	130
FBVFH100LG	100,00	3,94	45,00	55,00	50,80	642	100	155	160
FBVFH120LG	120,00	4,72	45,00	55,00	50,80	741	50	170	185

SAFE

Metal detectable



approx. 84° Shore A
FDA/EC/USDA compliant

PU 80 A SAFE capri blue



Order No.	Height (mm) H	Height (inch) H	Wave width (mm) B	Base width (mm) B1	Pitch off waves (mm) A	Approx. Weight (g/m)	Standard Roll (m)	Min. pulley diameter Ø (mm)	Recomm. pulley Ø (mm)
FBVFH020LA	20,00	0,79	23,00	32,00	25,40	174	100	35	70
FBVFH030LA	30,00	1,18	23,00	32,00	25,40	220	100	55	80
FBVFH040LA	40,00	1,57	23,00	32,00	25,40	265	100	75	90
FBVFH050LA	50,00	1,97	23,00	32,00	25,40	310	100	80	100
FBVFH060LA	60,00	2,36	45,00	55,00	50,80	445	100	90	110
FBVFH080LA	80,00	3,15	45,00	55,00	50,80	544	100	125	130
FBVFH100LA	100,00	3,94	45,00	55,00	50,80	642	100	155	160
FBVFH120LA	120,00	4,72	45,00	55,00	50,80	741	50	170	185

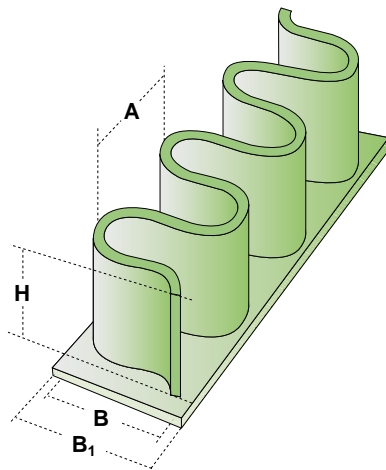



WELDING TOOLS & CONTROLLERS FOR CONVEYOR BELT VULCANIZERS

Our welding tools are especially designed for on-site installations and service - quick, compact and mobile.

Friction welding machine RS02	78
RS02 jaws	79
EErgo welding tool	80
EErgo-SETs	81
Multi TC welding tool	82
SG02/03 welding tool	83
Guide clamps	84
Scissors and edge cutter	86
Tools	87
PU-welding electrode	87
Guide clamp set FZ03	88
HP01 Hotpress	89
HP01 Moulds	90
HP01 Tools	91
Belt cutter	91
Joining Set CRIMP	91
Service kits	92
Controllers for conveyor belt vulcanizers	93
Checklist for selection of controller	95

Friction welding machine RS02



Made in Germany

PATENT

Scope of delivery:

- 1 pc. Friction welding machine RS02
- 1 set of standard profile jaws at your choice
- 1 pc. Allen key
- 1 pc. Scissors AS02
- 1 pc. Edge cutter SE02
- 1 pc. Carrying bag with durable and protective foam inlay

Dimensions (HxWxD): 390x105x123 mm

Weight: approx. 2452 g

Description

230 Volt Version
115 Volt Version

Order No.

FBWRS022230V
FBWRS022115V



**Perfect splice
within seconds!**

**THE tool for the
maintenance
technician!**

The patented Friction welding machine RS02 for Polyurethane profiles eliminates downtime with a perfect splice every time!

Features at a glance

- User-friendly and easy handling.
- No long heating-up and set-up times, spliced within seconds.
- Precise pressure and automatical O-positioning prevents uneven welds and premature failure.
- Automatic alignment ensures that the belt ends are aligned perfectly.
- Temperature variation is never a concern (no guess-work).
- Without the risk of injury or fire due to hot metal.
- Due to its small size the RS02 press can be used in confined spaces.
- Thanks to its exchangeable jaws the RS02 is suitable for splicing many different profiles up to \varnothing 6 mm made of Polyurethane.
- 100% repeatability.

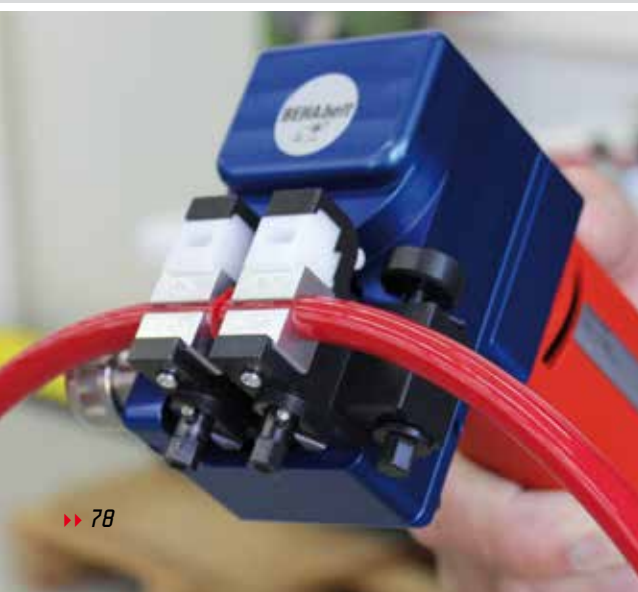

Our clamping jaw range

1 set of jaws consists of 4 parts

- For round belts from \varnothing 6 mm to 20 mm
- For V-belts from \varnothing 6x4 mm to 22x14 mm

On request we also manufacture jaws for PU special profiles.

Features at a glance

- Please note each belt profile requires a matching set of jaws.
- Therefore, please select the appropriate clamping jaws for the required profile geometry.



Application movie on
www.behabelt.com



Clamping jaws
also available for
custom-made profiles!

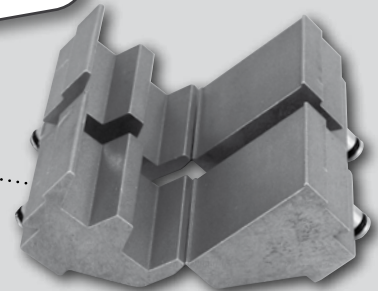

For Parallel V-belts



For round belts



For V-belts

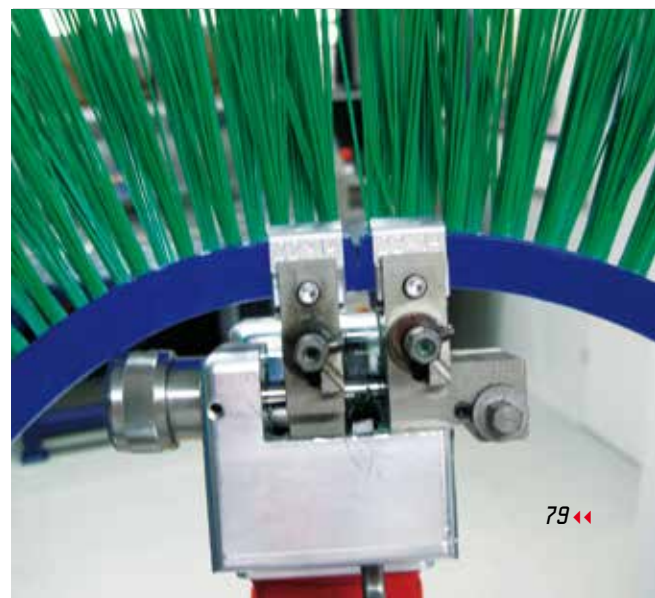

Eergo welding tool



INDUSTRIE
PREIS 2014
BEST OF

PATENT
pending

Specifically developed welding tool for PU and TPE

Scope of delivery:

- Eergo welding tool
- Carrying bag

Dimensions (HxWxD): 185x210x55 mm
Weight: approx. 379 g

Description
EEergo 230 V
EEergo 115 V

Order No.
FBWEE001
FBWEE005

EERGO Works. Simple. Safe.

The first welding tool specifically developed for joining of PU and TPE profiles.
Designed with practicable use in mind.

Features at a glance

- Strong, fiberglass-reinforced ergonomic housing.
- Unique control panel for one-handed operation.
- No adhesion of PU and TPE materials, thanks to Teflon-coated welding paddle.
- Also readjusts automatically if there is a draft.
- Easy cleaning with cloth.

Highlights



Heats-up in less than 2 minutes.



Innovative safety rest for safe placement on the work surface.



Ergonomic design for a natural working position.



Easy to use temperature selector regulates TPE PU correct temperature to weld PU or TPE profiles.

Spare paddle for Eergo

Spare paddle for Eergo

Dimensions (HxWxD):
43x65x6mm



Description
Spare paddle EERGO

Order No.
FBWEE002

BEHAbelt EErgo Pro welding tool

- EErgo welding tool
- Carrying bag

Description
EErgo 230 V
EErgo 115 V

Order No.
FBWEE001
FBWEE005



BEHAbelt EErgo-Set "small" Professional welding set for small profiles: Round belts up to 10mm and V-belts up to profile 10x6 (Z)

- EErgo paddle welding tool
- 2 pcs. guide clamps FZ01
- Edge cutter SE02
- Scissors AS02 with stop
- Carrying bag small

Description
EErgo-Set "small" 230 V
EErgo-Set "small" 115 V

Order No.
FBWEE003
FBWEE006



BEHAbelt EErgo-Set "universal" Professional welding set for small and big profiles: round belts all sizes an V-belts up to profile 32 (D)

- EErgo paddle welding tool
- 1 pc. clamp guide FZ02/03
- Edge cutter SE02
- Scissors AS04 with stop
- 2 pcs. clamp guides FZ01
- Carrying bag big

Description
EErgo-Set "universal" 230 V
EErgo-Set "universal" 115 V

Order No.
FBWEE004
FBWEE007



Multi TC welding tool

Polyurethan PU 290 °C
Polyester TPE 240 °C



Continuously
temperature control
200-300°C

Scope of delivery:

- Multi TC welding tool
- Temperature-controlled welding tool
for two temperature ranges:
PU 290 °C / Polyester 240 °C

Dimensions (HxWxD): 295x35x25 mm
Weight: approx. 251 g

Description
Multi TC 230 V

Order No.
FBWMTC230

Multi TC welding tool for PU and TPE profiles

The top-selling
welding paddle
worldwide!

The BEHAbelt Multi TC welding tool is the proven welding tool for Polyurethane and Polyester profiles on the market that ensures a constant welding temperature through continuous temperature control.

Features at a glance

- Easy and safe handling.
- Very fast heating-up period.
- Variable temperature setting means of adjusting wheel.
- LED display for display of optimum welding temperature.
- Small, hand and robust.
- With two temperature ranges: for Polyurethane and Polyester.
- Continuous welding temperature through temperature control even at long-term operation.
- Teflon coated welding paddle.
- Easy cleaning with cloth.

Highlights

- Minimization of welding errors and breakdown time through safe, secure and fast welding of PU and TPE profiles.
- Your choice for non-reinforced Polyurethane and Polyester profiles!

Spare paddle for Multi TC

Spare paddle for Multi TC

Dimensions (HxWxD):
72x35x1 mm



Description
Spare paddle for Multi TC

Order No.
FBWMTC1

Spare paddle for Multi TC for flat profiles

Dimensions (HxWxD):
250x70x2 mm



Description
Spare paddle for Multi TC

Order No.
FBWMTC2

Welding tools SG02 or SG03

Economical - A separate welding tool for each temperature range (PU/TPE).

Features at a glance

- Easy and safe operation.
- Fixed, unregulated temperature setting.
- Reaches the welding temperature after approx. 10 minutes.
- Small, convenient and tough welding tool.
- No adhesion of PU and TPE materials, thanks to Teflon-coated welding paddle.
- Easy to clean with a cotton cloth.
- **Caution!** Not suitable for continuous use.

Highlights

- Minimise downtime through fast and easy welding of PU and TPE profiles.
- Your choice for un-reinforced profiles!

Spare paddle for SG02/03

Spare paddle for SG02/03

Dimensions (HxWxD):
110x35x1mm



Description
Spare paddle SG02/03

Order No.
FBWTC72

Spare paddle for SG02/03 for flat profiles

Dimensions (HxWxD):
225x75x2mm



Description
Spare paddle SG02/03

Order No.
FBWTC76



SG02



SG03

Scope of delivery:

- SG02 welding tool for Polyurethan (PU) 290 °C - 300 °C
- SG03 welding tool for Polyurethan (TPE) 215 °C - 240 °C

Dimensions (HxWxD): 280x33x33 mm
Weight: approx. 227 g

Description
SG02 PU - 230 V
SG03 TPE - 230 V

Order No.
FBWSG02
FBWSG03



Guide clamps

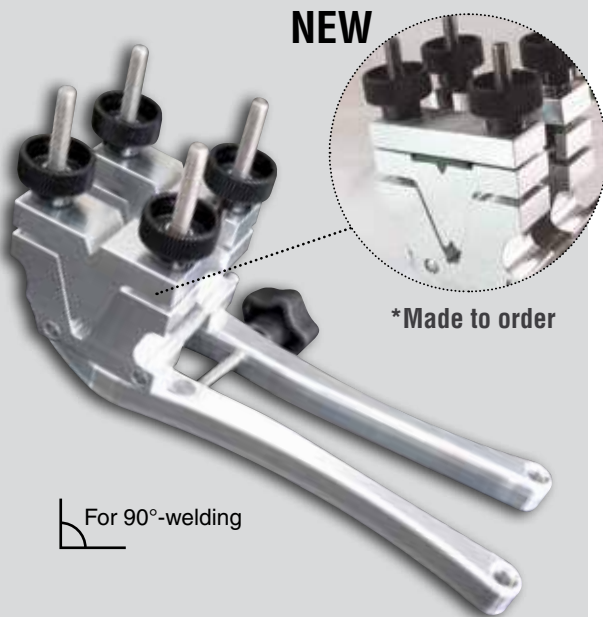

For 90°-welding

Dimensions (HxWxD): 205x90x100 mm
Weight: approx. 617 g

Description

Guide clamp FZ02/3
Guide clamp FZ02/2 S

Order No.

FBWFZ02/3
FBWFZ02/3S

Guide clamp FZ02/3

NEW - adapter for custom-made profiles

Guide clamp FZ02/3 standard

Robust and accurate for V-belts up to profile 32 (D) and round belts from \varnothing 8 mm.

*Guide clamp FZ02/3 Custom adapter

Custom adapter for the guide clamp FZ02/3 for custom profile geometries according to your specifications.

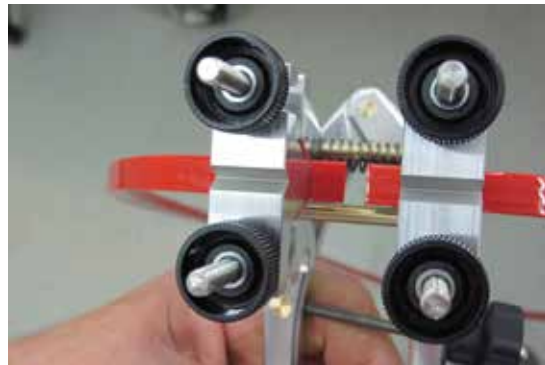

Guide clamp FZ02/3F

NEW - Suitable for flat belts!

Guide clamp FZ02/3F

Robust and accurate.

Width max. 60 mm and Height 1,6 - 5 mm.



For 90°-welding

Dimensions (HxWxD): 205x90x100 mm
Weight: approx. 617 g

Description

Guide clamp FZ02/3F

Order No.

FBWFZ02/3F

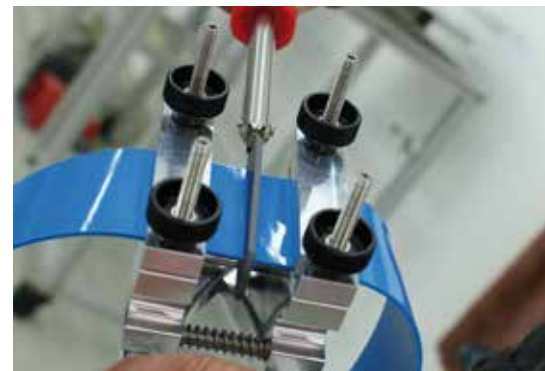

Guide clamp FZ01 Vario tt 2-in-1 with exchangeable profile jaws

Available from
 Q3 / 2015

Guide clamp FZ01 Vario Metal can be assembled in two operating modes. With and without handle!

Convenient and tough for round belts up to \varnothing 10 mm and V-belts up to profile 10 (Z).

Exchangeable profile jaws allow custom profiles to be handled.

Highlights

- Fast, reliable and exceptionally precise connecting of PU and TPE profiles.
- Special inserts for: PJ2 and PJ3 ribbed V-belts.
- Your choice for standard and custom profiles!

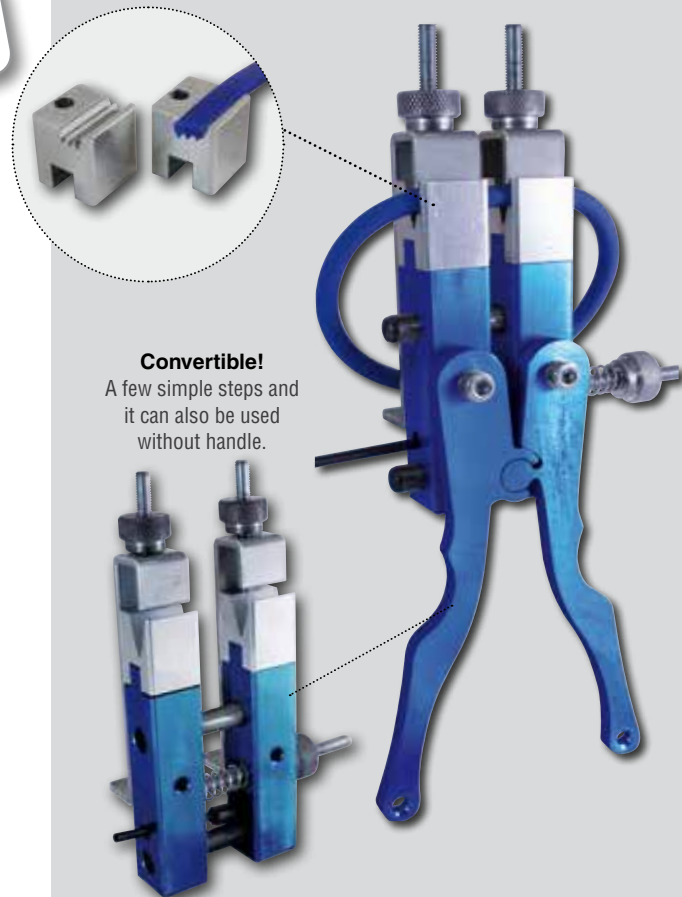

Convertible!
 A few simple steps and it can also be used without handle.

Dimensions (HxWxD): 240x125x50 mm
 140x195x50 mm without handle

Weight: approx. 420 g
 approx. 320 g without handle

Description
 FZ01 Vario

Order No.
 on request

Guide clamp FZ01

Handy and lightweight for round belts up to \varnothing 10 mm and V-belts up to profile 10 (Z) round belts up to \varnothing 10 mm and V-belts up to profile 10 (Z)

Highlights

- Fast, reliable and exceptionally precise connecting of PU and TPE profiles.
- Your choice for standard profiles!



Dimensions (HxBxD): 127x70x35 mm
Weight: approx. 13 g

Description
 Guide clamp FZ01

Order No.
 FBWFZ01

Scissors and edge cutter



Scissors small (standard)

Scissors small (standard)

AS02 with stop

For round belts up to \varnothing 12 mm.

Description
AS02

Order No.
FBWAS02



Scissors big (standard)

Scissors big (standard)

AS03 with stop

For 90° cut and angle cut.

Description
AS03

Order No.
FBWAS03



Scissors big (pro)

Scissors big (Pro)

Scissors big (pro) Scissors AS04 with stop

Scissors with movable angular stop.
For 45°, 60°, 75°, 90°, 105°,
120° and 135°-cuts.

Description
AS04

Order No.
FBWAS04



Edge cutter SE02

Edge cutter SE02

Edge cutter with special blade to remove
the welding bead.

Description
SE02

Order No.
FBWSE02

Belt tensioner

RSH01 & RSH02

Belt tensioner for tensioning of round and V-belts.

Available in large and small versions.

RSH01 450 mm (18") clamp travel, suitable up to approx. 1m belt length.

RSH02 900 mm (36") clamp travel, suitable up to approx. 9 m belt length.



Small:
Dimensions (HxWxD): 690x320x90 mm
Weight: approx. 1935 g

Big:
Dimensions (HxWxD): 1150x320x90 mm
Weight: approx. 2419 g

Description	Order No.
RSH01 (450 mm)	FBWRSH01
RSH02 (900 mm)	FBWRSH02

Ball-bearing mounted holder KS 75

VERY practical!

Bench vise with ball joint for EErgo welding tool

Mount your EErgo welding tool on a flexible, ball-bearing mounted holder to simplify stationary connecting of your belt profile.

NOTES

- Be careful not to over tighten the jaws to avoid damage to the body of the EErgo.
- When setting up, make sure that the EErgo cable is not pinched.
- Sufficiently tighten the ball joint and table fixing so that the adjusted position remains fixed.

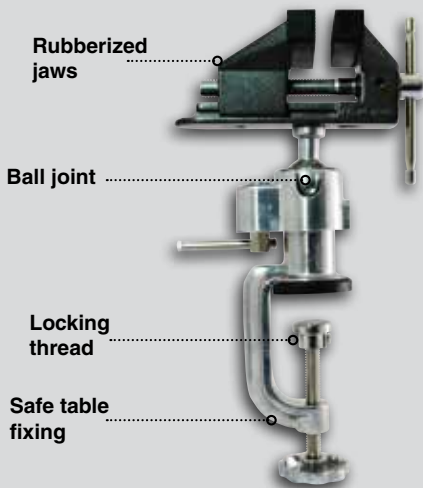

Dimensions (HxWxD): 280x80x150 mm
Weight: approx. 854 g

Description	Order No.
KS 75	FBWKS75

Hot air gun with PU/TPE electrodes for flat belt welding

A simple and cost-effective method for connecting flat belts with a hot air gun and welding electrodes made of PU or TPE (6x6 mm) for belt thicknesses of 1.6...3 mm.

Description	Order No.
Hot air gun with welding attachment	on request
Welding electrode (PU95A) 6x6 mm	FBSEM6X6...
Welding electrode (TPE55D) 6x6 mm	FBSES6X6...



Guide clamp set FZ03

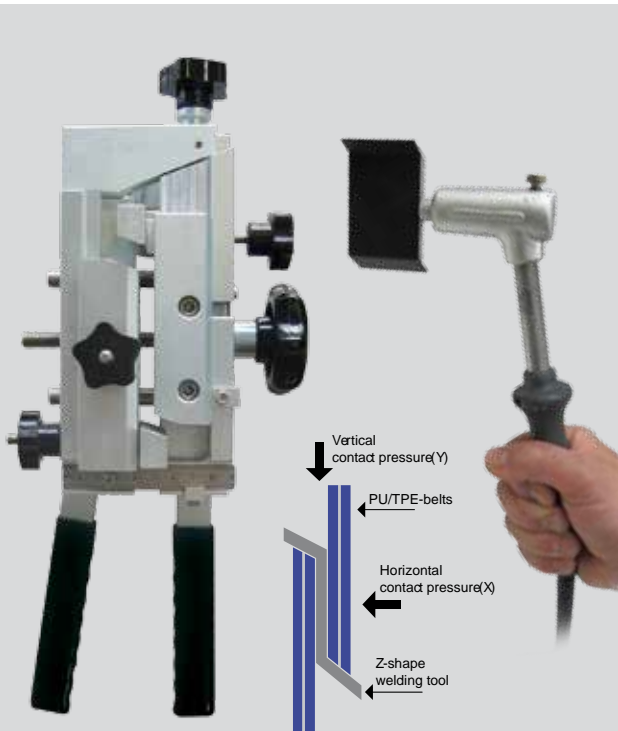

Scope of delivery

- 1 pc. Aluminium box
- 1 pc. Guide clamp FZ03
- 1 pc. Z-shape welding tool H15, 230 Volt or 115 Volt
- 1 pc. Scissors with movable stop AS04
- 1 pc. Edge cutter SE02
- 1 set of clamping pieces for round belts 8,0; 9,5; 10,0, 12,0; 12,5, 15,0mm
- 1 set of clamping pieces for V-belts (A, B, C)

Dimensions (HxWxD): 374x150x70 mm

Weight: approx. 2120 g

Description

FZ03 Set 230 V

FZ03 Set 115 V

Order No.

FBWFZ03SET01

FBWFZ03SET02

The easy solution for overlap welding!

The guide clamp FZ03 is used for safe and accurate overlap welding of round and V-belts made of Polyurethane and Polyester.

Features at a glance

- Professional and safe overlap welding of Polyurethane and Polyester profiles.
- Due to its small size the FZ03 clamp can be used in confined spaces.
- With the handy FZ03-set you have all essential tools and accessories ready at your finger tips.
- The unique design allows that the splice is compressed both in horizontal and vertical direction!

Highlights

- Accurate and very strong joint.
- ➔ Less failures due to breaking splices, as both vertical and horizontal contact pressure seals splice and thus avoids splices opening up!



Controller guided hotpress for perfect butt and overlap welding

The use of the unique BEHAbelt HP01 hotpress is the best and most secure technology for welding PU and TPE profiles, flat belts and timing belts up to a width of 50mm.

Features at a glance

- Very easy to use.
- Reduces operator errors through a fully automatic and controlled welding and vulcanization process.
- Thanks to its exchangeable moulds the HP01 is suitable for splicing many different profiles and flat belts made of PU and TPE as well as timing belts.
- User friendly operation through self-explanatory menu of controller (no expertise required).
- Perfect welding within minutes.
- Temperature variation is never a concern (no guesswork).
- Real time data logging & diagnostics function for quality assurance of the splice.
- Different types of welds possible (overlap welds, butt welds and angle welds).
- Due to its small size and the hook for hanging up the press during the welding process, the HP01 can be used in confined spaces "on-site".
- Best welding solution for reinforced profiles (aramid, polyester and steel) through overlap welding.

Highlights

- Best welding solution for reinforced profiles (aramid, polyester and steel) through overlap!
- ➔ Your choice for reinforced profiles, profiles made of Polyester, flat belts, special profiles and timing belts!



Shaft for HP01 to use with torque wrench available as accessory
FBWHPSD12

The HP01 hotpress makes a perfect splice every time, on every site!

Prevents fully automated vulcanizing and cooling process application errors and thus ensures maximum process reliability.

Available with air or water cooling!



Heating plate dimensions:
120 x 60 mm

Scope of delivery

- Hotpress HP01 with air or water cooling
- Water cooled version: Cooling unit with pump 6,4 l
- Controller HP01
- Edge cutter SE02
- Screw driver
- Scissors AS04
- Aluminium case

Dimensions (HxWxD): 240x167x200 mm
Weight: approx. 4800 g

Air cooled version

Description

Standard Set HP01/Air cooling/230 Volt
Standard Set HP01/Air cooling/115 Volt

Order No.

FBWHP011L230
FBWHP011L115

Water cooled version

Description

Standard Set HP01/Water cooling/230 Volt
Standard Set HP01/Water cooling/115 Volt

Order No.

FBWHP011W230
FBWHP011W115



- Air cooling = compact, portable design

- Water cooling = Higher cooling capacity

Moulds for HP01

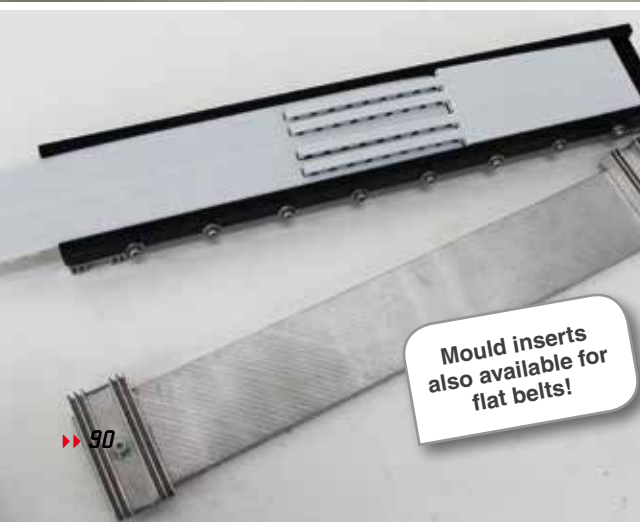
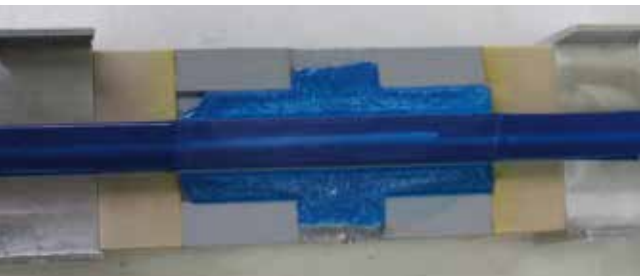
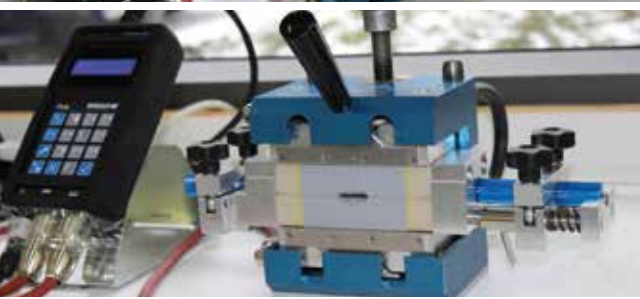
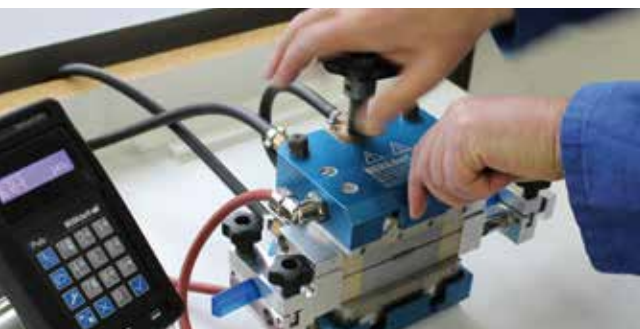
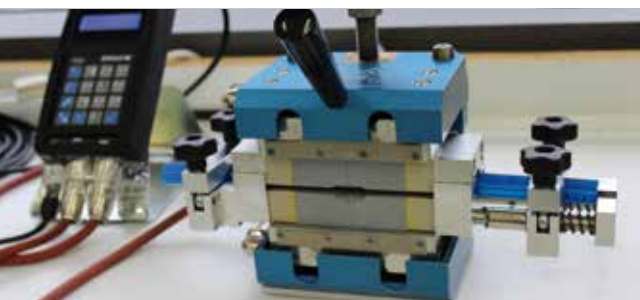
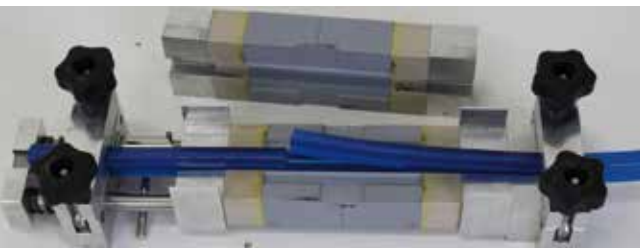

Mould inserts also available for flat belts!

Standard moulds for HP01 Hotpress

Standard moulds for PU and TPE Round- and V-belts.

Standard moulds

Order No.	Description	Dimension
FBWFS060	Standard mould HP01 for round belts	∅ 6,0mm
FBWFS063	Standard mould HP01 for round belts	∅ 6,3mm
FBWFS070	Standard mould HP01 for round belts	∅ 7,0mm
FBWFS080	Standard mould HP01 for round belts	∅ 8,0mm
FBWFS095	Standard mould HP01 for round belts	∅ 9,5mm
FBWFS100	Standard mould HP01 for round belts	∅ 10,0mm
FBWFS120	Standard mould HP01 for round belts	∅ 12,0mm
FBWFS125	Standard mould HP01 for round belts	∅ 12,5mm
FBWFS150	Standard mould HP01 for round belts	∅ 15,0mm
FBWFS180	Standard mould HP01 for round belts	∅ 18,0mm
FBWFS200	Standard mould HP01 for round belts	∅ 20,0mm
FBWFS130X080	Profile adapters for V-belts	13x8mm
FBWFS170X110	Profile adapters for V-belts	17x11mm
FBWFS220X140	Profile adapters for V-belts	22x14mm
FBWFS170X113	Profile adapters for V-belts	17x11,3mm BLUEPOWER

Special moulds on request

Timing belt moulds for HP01 Hotpress

Standard moulds for PU timing belts (max. width up to 50 mm).



Timing belt moulds

Order No.	Description	Width
FBWFZHTD5MN	Timing belt mould HTD5	B:50mm
FBWFZHTD8MN	Timing belt mould HTD8	B:50mm
FBWFZT5N	Timing belt mould T5	B:50mm
FBWFZT10N	Timing belt mould T10	B:50mm
FBWFZAT5N	Timing belt mould AT5	B:50mm
FBWFZAT10N	Timing belt mould AT10	B:50mm
FBWFZAT20N	Timing belt mould AT20	B:50mm
FBWFZHO	Timing belt mould H	B:50,8mm/2"
FBWFZLO	Timing belt mould L	B:50,8mm/2"
FBWFZRPP8MN	Timing belt mould RPP 8M	B:50mm

Belt cutter SH01 for reinforced profiles

Designed to accurately cut and prepare reinforced profiles for overlap welding with the BEHAbelt HP01 hot press.

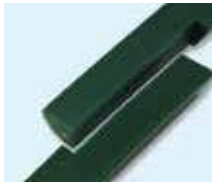

Before overlap welding



Result after overlap welding

Profile adapters for round belts

Order No.	Description	Dimension
FBWSH1R060	Profile adapters for round belts	∅ 6,0mm
FBWSH1R063	Profile adapters for round belts	∅ 6,3mm
FBWSH1R080	Profile adapters for round belts	∅ 8,0mm
FBWSH1R095	Profile adapters for round belts	∅ 9,5mm
FBWSH1R100	Profile adapters for round belts	∅ 10,0mm
FBWSH1R100	Profile adapters for round belts	∅ 10,0mm
FBWSH1R120	Profile adapters for round belts	∅ 12,0mm
FBWSH1R125	Profile adapters for round belts	∅ 12,5mm
FBWSH1R150	Profile adapters for round belts	∅ 15,0mm
FBWSH1R180	Profile adapters for round belts	∅ 18,0mm
FBWSH1R200	Profile adapters for round belts	∅ 20,0mm

Profile adapters for V-belts

Order No.	Description	Dimension
FBWSH1K13	Profile adapters for V-belts	13x8 (A)
FBWSH1K17BP	Profile adapters for V-belts bluepower	17 x 11,3
FBWSH1K17	Profile adapters for V-belts	17x11 (B)
FBWSH1K22	Profile adapters for V-belts	22x14 (C)

Profile adapters for special profiles on request

Joining Set CRIMP* - for steel reinforced profiles (new principle)

*Ferrules

The new and improved CRIMP connection lets you achieve perfect results when connecting belts with steel reinforcement.

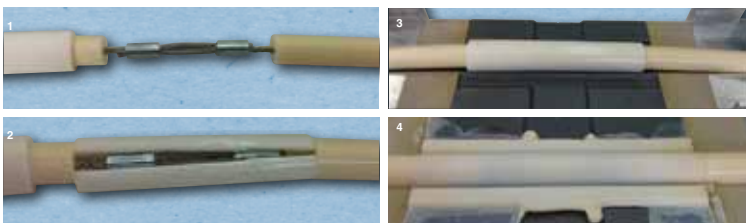

Scope of delivery

Belt cutter SH01 for reinforced profiles incl. one profile adapter of choice.

Adapters available for the following profiles:

- Round belts ∅ 6,0 - 20,0mm
- V-belts 13 x 8 (A), 17 x 11 (B), 22 x 14 (C), bluepower

Dimensions (HxWxD): 200x80x45 mm

Weight: approx. 1302 g

Description

Belt cutter SH01 with one profile adapter of choice

Order No.

FBWSH1



Profile adapters for round belts



Profile adapters for V-belts



Inner and outer shell is supplied by the meter

Scope of delivery Joining Set RH2

- 1 pc. nylon case
- 1 pc. crimping tool RH-2
- 3m respectively of polyester sleeves (outside/inside)
- 100 pcs. AL crimps

Description

Joining set RH2
Polyester sleeves inside (3m)
Polyester sleeves outer (3m)
AL crimps 2 mm (100 pcs.)

Order No.

FBWZRH2SET1
on request
on request
on request

Service kits

Carrying bag big

Suitable for the following tools:

Welding tool: EErgo
Guide clamp: FZ01 (2x) or FZ02/3
Scissors: AS02, AS03 or AS04
Edge cutter: SE02

Description	Order No.
Carrying bag big (without content)	FCT000000003



Carrying bag medium

Suitable for the following tools:

Welding tool: EErgo
Guide clamp: FZ01 (2x)
Scissors: AS02
Edge cutter: SE02

Description	Order No.
Carrying bag medium (without content)	FCT000000002



Carrying bag small

Suitable for the following tools:

Welding tool: Multi TC, SG02 or SG03
Guide clamp: FZ01 (2x)
Scissors AS02 or edge cutter SE02

Description	Order No.
Carrying bag small (without content)	HTT31X20X05



PPuls Controller for vulcanizing and hotpress system

For welding profiles and flat belts with your hot press!

The PPuls Controller performs optimal, fully automated and precise welding with controlled temperature and cooling times.

Features at a glance

- Easy handling and transportation through robust industrial design and small handheld size.
- User friendly operation with self-explanatory menu system (no expertise) required.
- Storage and change of welding recipes within seconds through integrated memory.
- Fully automated vulcanizing & cooling cycle.
- High flexibility for different power grids and presses.
- Real time data logging & diagnostic functions (Xpert version).

Before

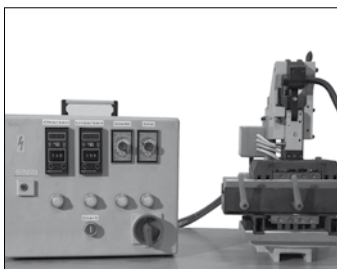

After



Sounds interesting?

Call us at +49 (0) 7684 / 907-0

The checklist on page 95 can help you make your selection.



PPuls Element

Fully automated welding process guarantees highest welding quality and leads to an increase of your productivity (110V & 230V).

Available as Standard and Xpert version



PPuls Extended

Fully automated welding process guarantees highest welding quality and leads to an increase of your productivity (208V & 400V).

Available as Standard and Xpert version



PPuls Relaisbox

Wherever operating voltages higher than 400 V are given, the PPuls Relaisbox is a robust solution in combination with good weatherproof protection.

PPuls Controller for vulcanizing

Controllers for vulcanizing and hotpress system

Our PPuls Controllers are part of a vulcanizing and hotpress system, designed to replace standard large control cabinets.

The main function is to control the vulcanizing cycle with platen temperatures and cycle time.

The compact size of the controller along with the broad functionality of the unit makes the PPULS controller a good option when replacing controllers on just about any press.



Sample	Set-Top	Set-Bot	Temp-Top	Temp-Bot	Pc
1	200	200	0	0	
2	200	200	22,8	23	
3	200	200	22,7	22,9	
4	200	200	22,9	23	
5	200	200	23,6	23,3	
6	200	200	25	24	
7	200	200	27,2	25,2	
8	200	200	29,8	26,9	
9	200	200	32,7	29	
10	200	200	35,8	31,4	
11	200	200	38,8	33,9	
12	200	200	41,8	36,6	
13	200	200	44,7	39,4	
14	200	200	47,5	42,1	

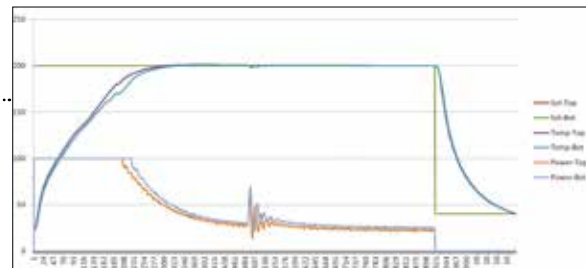

Advantages and Highlights

- Fully automated vulcanizing & cooling cycle for hot and vulcanizing presses
- PID-regulation for temperature control including control of maximum temperature difference between top and bottom platen
- Handy, compact and robust for on-site work
- User friendly operation with self-explanatory menu system (no expertise required)
- Memory storage for 200 different recipes
- Real-time data logging for process monitoring and proof to certify the splice (ISO 9001). Includes PC software to read out the data and to create and download recipes
- Various other functions depending on version (heating up in steps, failure diagnostics, multi lingual, ...)



Checklist for PPuls-Controller-Series

Project		Phone	
Name		E-mail	
Address			

PLEASE SEND TO:

Fax: +49 (0) 7684 / 907-101

E-Mail: tech@behabelt.com



Operating voltage of the heating						
A	115 V	<input type="checkbox"/>	●	●	●	
B	208 V	<input type="checkbox"/>	●	● (1)	● (1)	●
C	230 V	<input type="checkbox"/>	●	●	●	● (1)
D	400 V	<input type="checkbox"/>		● (1)	● (1)	●
E	480 V	<input type="checkbox"/>				●
F	600 V	<input type="checkbox"/>				●
<input type="checkbox"/> Different instructions:						
Power consumption per heating plate and per phase						
G	≤ 5A	<input type="checkbox"/>	●	●	●	●
H	≤ 9A	<input type="checkbox"/>		●	●	●
I	≤ 16A	<input type="checkbox"/>		● (2)	●	●
Internal interconnection of the heating						
J	single phase	<input type="checkbox"/>	●	●	●	●
K	3-phase star connection (center connection accessible)	<input type="checkbox"/>	● (4)	● (3)	● (3)	●
L	3-phase star connection (center connection not accessible)	<input type="checkbox"/>				●
M	3-phase delta connection	<input type="checkbox"/>				●
Mains connection						
N	"Schuko" (3-pole)	<input type="checkbox"/>	●	● (5)	● (5)	●
O	NEMA 5-15 (3-pole)	<input type="checkbox"/>	● (6)			
P	CEE 16A (5-pole)	<input type="checkbox"/>		●		●
Q	CEE 32A (5-pole)	<input type="checkbox"/>			●	●
R	NEMA L6-30 (3-pole)	<input type="checkbox"/>			●	●
S	NEMA L15-30 (4-pole)	<input type="checkbox"/>			●	●
<input type="checkbox"/> Different instructions:						
Sensor-Type						
T	PT100	<input type="checkbox"/>	●	●	●	●
U	Type-K thermocouple	<input type="checkbox"/>	●	●	●	
U	Type-J thermocouple	<input type="checkbox"/>	●	●	●	

(1) Only in combination with J

(2) Only in combination with A or C

(3) Only if the total current of all phases ≤ 16A and A or C

(4) Only if the total current of all phases ≤ 5A and A or C

(5) With adapter FBEC11 and only if the total current of all phases ≤ 16A and C

(6) Only in combination with A

KNOW-HOW

In our section "KNOW-HOW" we have summarised frequently asked questions about using our products in order to make things easier for you.

PU and TPE material properties	98
Chemical characteristics of PU and TPE	99
General directives for plastics	100
Pulley shapes	101
Pretension and take-ups	104
Calculation of belt length.....	105
Coefficient of friction	106
Working tension for PU and TPE	107
Manufacturing tolerances	108
LubeSite® Lubricators	109
BEHA worldwide Group of companies	111



PU and TPE material properties

Conveyor belts made of Polyurethane and Polyester

Our mission

Over 40 years BEHA has produced high quality thermoplastic weldable belts made of Polyurethane and Polyester. Those belts are used for drive applications and conveying.

We use only the very best raw materials and combine them with our experience in the extrusion field to provide time tested and proven products. New products are added to the line only after they have been tested in the laboratory and in the field.

Our mission is to supply our customers with the highest level of quality and innovation in the thermoplastic extrusion industry worldwide. In the following pages, you will find all the important information about material properties, purposes, technical data and joining methods.

Very good properties

The excellent melting ability of the material enables easy welding in order to obtain endless belts. Not only does this result in simplified installation of belts but also allows for reduced inventory as it is no longer necessary to store belts in different lengths.

In the majority of cases when a common drive belt has to be changed, machine and conveyor systems have to be disassembled for the belt replacement. This is not the case if you use BEHAbelt products. BEHAbelt drive and conveyor belts can be installed and endlessly finished without the need of disassembly and in a short period of time. BEHA Innovation GmbH develops and manufactures handy joining tools, which can be used for this purpose. When our homogeneous materials are properly joined with BEHAbelt equipment, the splice is the same strength of the belt.

Material qualities

BEHAbelt profile belts and homo-geneous flat belts are produced in different compounds in PU 60 A (approx. 65° Shore A) - 95 A (approx. 98° Shore A) and TPE 40 D (approx. 40° Shore D) up to TPE 63 D (approx. 63° Shore D). The selection of materials should be based on application requirements.

Material properties

- High tensile strength
- Excellent wear and abrasion resistance
- High resilience, low level of belt stretching
- Resistance to oil, grease, dirt and most chemicals
- Temperature resistance from -30°C to +80°C (dynamic)
- High coefficient of friction
- Silent running
- Excellent weldability
- Hydrolysis resistant
- Hygienic and easy to clean
- FDA/EC compliant



Chemical characteristics of PU and TPE



General

Thermoplastic material can be used in a variety of applications where there is interaction with various chemicals.

Chemical resistance depends on the period of exposure, the temperature, the quantity, the concentration and the type of the chemical substance. It is therefore difficult in any case to make a clear distinction between the effects described below. In the case of chemical degradation of polyurethane the chemical reaction results in cleavage of the molecular chains. In the course of degradation, polyurethane loses strength, and in extreme cases this can lead to disintegration of the part.

For critical applications, a detailed resistance test considering both swelling and the affect on mechanical properties is recommended.

Swelling

Swelling is the fundamental physical process of the absorption of liquid substances by a solid. In this process, the substance enters into the material without chemical interaction.

This results in an increase in volume and weight with a corresponding reduction in mechanical values. After evaporation a reduction in swelling occurs and the original properties of the product are almost completely restored.

Swelling is a reversible process. By using reinforcements in the polyurethane, for example polyester or aramid cords, you can almost avoid this mechanical impact on the material.



Hydrolysis resistance

If polyester-based polyurethanes are exposed for lengthy periods to hot water, moisture vapour or tropical climates, an irreversible break-down of the polyester chains occurs through hydrolysis. This results in a reduction in mechanical properties. This effect is more marked in flexible grades, where the polyester content is correspondingly higher than in the harder formulations.

Degradation of polyester-based polyurethanes is however rarely experienced at room temperature. Because of its chemical structure, polyester-based polyurethanes are much more resistant to hydrolytic degradation.

Microbiological resistance

When using polyester-based thermoplastic polyurethane under climatic conditions of high heat and humidity, parts can be damaged by microbiological attack. In particular, microorganisms producing enzymes are able to affect the molecule chains of polyester-based TPU.

The microbiological attack initially becomes visible as discoloration.

Subsequently, surface cracks occur which enable the microbes to penetrate deeper and to cause a complete destruction of the TPU.



General directives for plastics with direct food contact

There are several country-specific and global directives for the application of food contact materials. In general, all food contact materials have to be produced according to the principles of Good Manufacturing Practice (avoiding the occurrence of a health hazard or any other unacceptable change in the composition of the food during its intended use).



FDA Guideline "Title 21: Code of Federal Regulations"

The Food and Drug Administration of the Public Health Service of America is the world's best-known authority involved in consumer protection in respect of potential detrimental influences. The FDA has prepared a review "Title 21: Code of Federal Regulations" in respect of their approval of raw materials in a processed or finished state, and also specified the conditions under which the approval is valid.



EC Directive 1935/2004, EU Directive No. 10/2011

The framework Regulation EC 1935/2004 (EU Directive No. 10/2011) Food Contact and belonging specific Directive 2002/72/EC Monomers Additives of the European Parliament regulates plastics intended to come into contact with foodstuffs. The EU legislation for food contact materials is based on positive lists of the substances and maximum limits of migration into food. Only substance on these positive lists may be used for manufacturing plastics that are designated to have food contact. Furthermore,

you have to show the evidence of the global and specific migration. This can be requested and interpreted differently depending on the application.



Federal Institute for Risk Assessment (BfR) recommendation "Plastics in the foodstuff chain"

The Federal Institute for Risk Assessment (previously the Federal Institute for Consumer Health Protection and Veterinary Medicine (BgVV)) was formed to increase the health protection of consumers and processes scientific recommendations and recognized orientation aids for possible health risks through materials that come into contact with foodstuff. These recommendations are listed in the "Recommendations within the framework of the German Food and Feed Code (LFGB)".



USDA

The official United States Department of Agriculture is a part of the Federal Government of the United States of America. In addition to checking the use of raw materials in accordance with the FDA, the USDA also checks the suitability of the finished product (belt/conveyor) with regard to the cleanability of the product constitution (surfaces). Conformity in accordance with the USDA is primarily required for equipment in the processing of meat, poultry and milk in the United States of America.

HACCP concept

The Hazard Analysis and Critical Control Points concept (abbreviated: HACCP concept or HCCP concept) is a tool clearly aligned for structured and preventive measures. It is used to prevent risks in conjunction with foodstuff that can result in the consumer becoming ill. This concept was developed around 1960. In German law, the HACCP concept was initially anchored into the Foodstuff Hygiene Ordinance from 1998. The EC Ordinance 853/2004 also provides for mandatory application of the HACCP concept in all companies engaged in the production, processing and sales of foodstuff.

The hygiene package accepted by the EU in 2004 came into force on the 1st January 2006. Herein, it is decreed that only foodstuff conforming to the directives of the HACCP must be handled and introduced into the Union.

Principles of the HACCP:

1. Carrying out a risk analysis
2. Identification of the critical checking points that the foodstuff is safe
3. Determining the intervention limits at the respective critical checking points
4. Establishing applicable monitoring procedures on the critical checking points
5. Establishing corrective measures in the event of deviations
6. Establishing assessment measures for checking the efficiency of the HACCP system determined
7. Establishing documentation of the measures

Pulleys for round belts and V-belts

Drive pulley and idler pulley

The drive pulley and idler pulley should be designed according to DIN 2217 (refer to BEHAbelt recommendation on following page). Please choose the minimum pulley diameters according

to the values listed in tables. We have selected an appropriate shore hardness for conveying at slow speeds (one Meter per second). It is recommended to always place the drive pulley when

possible at the head of the conveyor so the product is pulled through the system.

“What impact has the pulley diameter on the belt?”

The pulley diameter has a major impact on the lifetime of a belt. The minimum pulley diameters or larger as specified in this BEHAbelt delivery programme should be followed. If the pulley diameter is too small this always reduces

lifetime considerably due to resulting extreme bending cycles leading to early material fatigue.

The specified minimum pulley diameters always refer to a 180° wrap. The wrap angle indicates by how many

degrees the belt will be guided around the pulley and thus has contact with the pulley.

Pulleys for round belts

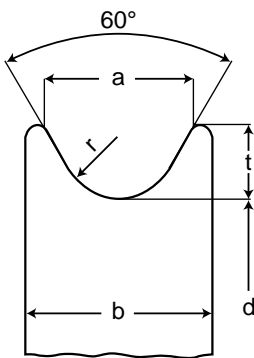

Recommended pulley dimensions – dimensions in mm

Belt Ø	2	3	4	4,8	5	6	6,3	7	8	9,5	10	12	12,5	15	18	20
a	4,5	5,5	7	8	8	10	10	11	12	14,5	15	18	18,5	23	28	30
b	6,5	8	10	12	12	14	14	15	16	19	19	22	23,0	27	32	36
t	2,5	3	3,5	4	4	5	5	5,5	6	7	7,5	9	9	12	14	15
r	1,4	1,9	2,5	3	3	3,5	3,5	4	4,5	5,5	5,5	6,5	7	8	9,5	11

Please select the appropriate minimum pulley diameter according to the different PU/Polyester qualities. The best qualified materials for pulleys are steel, high-alloyed steel, aluminum or Polyamid when it comes to plastic. Please keep in mind the low friction coefficient μ when using plastic material.

Pulleys for V-belts

Profile acc. to DIN 2215	6	8	10	13	17	22	32
Global Standard acc. to ISO 4184	Y	M	Z	A	B	C	D
Upper width b (mm)	6	8	10	13	17	22	32
Height h (mm)	4	5	6	8	11	14	20
Lower width u (mm)	3,3	4,55	5,9	7,5	9,4	12,35	18,25
Pulley angle α	$\angle 36 - 38^\circ$						
Groove width b1	6	8	10	13	17	22	32
	→ depending on how much the profile should stick out above the upper pulley edge						
Groove depth t (mm)	$h + 2,0\text{mm}$						

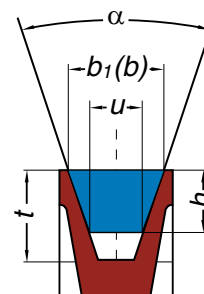

For BEHAbelt V-belts according to DIN 2215 / ISO 4184 pulleys for V-belts according to DIN 2217 / ISO 4183 have to be used.



Design of V-belt pulleys for round belts

In the field it is common to see round belts being run in V-belt pulleys. You need to know that this is not a perfect combination regarding geometry and that it is always recommended to use round belt pulleys instead.

The disadvantage of this “combination” is a typical wear in the belt flank where the belt is in contact with the pulley. There is also a risk that the round belt will be clamped by the V-shape of the pulley and thus stick in the V-shape.

This often can lead to additional belt elongation causing the belt to skip or wobble. Under such conditions lifetime of the belt will always be reduced. If you decide to use V-belt pulleys anyhow please choose a V-belt pulley design that allows the round belt also to touch the bottom of the pulley groove to minimize problems.

Regarding selection of pulley material we recommend in general to use for the drive pulleys steel or aluminum to have good grip with the TPU/TPE belts. Then you have the best conditions to transmit maximum power to drive the belt.

Please note that non-coated aluminum pulleys can lead to a discolouring of the belts. For supporting and deflection pulleys and supporting or guide rails we recommend using low friction materials like PE or HDPE to minimize friction. Please refer also to page number 96 in our catalogue where you can find an overview table stating the coefficient of friction of TPU/TPE with various materials.

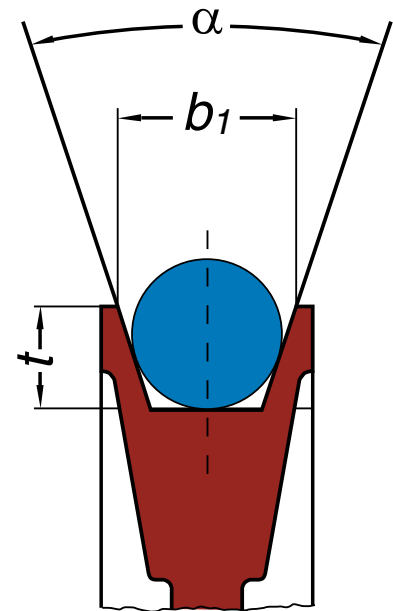

Pulleys for flat belt

Pulley crowning

In order to prevent the flat belts from slipping off, at least one of the pulleys must be crowned, preferably the larger pulley or the pulley with the largest wrap angle.

A uniform, symmetrical curvature is recommended. Don't use any pulleys with a conical or cylindrical-conical shape and avoid sharp edges under all circumstances.

Commercially available pulleys are usually crowned according to ISO 22. The higher the wrap angle, the greater the tracking effect of crowned pulleys.

Pulley width

The width of the pulleys should be at least 1.05 to 1.1 times the belt width.

Pulley running surface

Clean and smooth running surfaces increase the efficiency and service life of drive belts.

Due to the risk of slip-stick and noise, the running surfaces of driving pulleys must be neither too smooth nor too rough (no knurled surfaces!), since this would lead to excessive belt wear and premature belt failure.

We recommend using running surfaces with a roughness of $R_a=3.2 \mu - 6.3 \mu$

Pulleys for flat belt: Table and calculation

Pulley diameter	Crown bow (h)
< 5,01 mm	0,10...0,16 mm
< 10,01 mm	0,12...0,18 mm
< 30,01 mm	0,14...0,22 mm
< 50,01 mm	0,17...0,28 mm
< 60,01 mm	0,20...0,32 mm
< 80,01 mm	0,24...0,40 mm
< 100,01 mm	0,30...0,50 mm
< 200,01 mm	0,60...1,00 mm

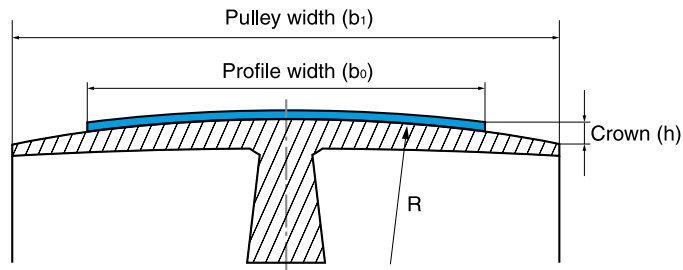

Calculation

$$\text{Manufacture radius (R)} = \frac{h}{2} + \frac{b_1^2}{8 \times h}$$

$$\text{Crown bow (h)} = \text{Pulley diameter} \times 0,003$$

Pretension

Suitable pretension of TPU or TPE belts is required to ensure functional operation.

We recommend pre-tensioning belts between 0,5 % - 10 % depending on the shore hardness of the belt and the length of the system.

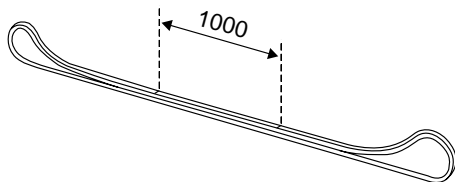

Prior to joining the belt, place it on a flat surface and mark two lines 1000 mm apart (for shorter belts, the distance can be reduced to 100 mm)

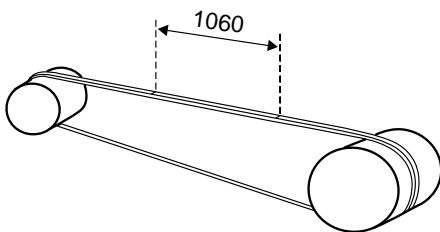

Mount the belt on the pulleys and tension it to increase the distance between the two marks. Elongate the belt until the distance reaches the requested value according to the marks. At a pretension of e.g. 6%, the marks have to be 1060 mm apart.

“How does the pretension of a belt impact its lifetime?”

The proper pre-tensioning of the belt is just as critical for belt performance as selecting the right belt and the right splicing system. For the recommended pretension please refer to the product tables of each belt in this delivery program.

What are the effects of wrong pretension? Too low pretension results in slippage of the belt which generates excessive heat. This causes belt deformation, heavy abrasion, breaking and jumping out of the pulley.

Too high pretension may cause damage to pulleys, shafts and bearings. The belt permanently is over-tensioned and will prematurely fail due to material fatigue and formation of cracks. Furthermore the belt loses its material resilience.



Pretension and bearing load

Tensioning devices

A variety of tensioning devices can be used to accommodate the different amounts of stretch in belts or to make the installation process easier. In addition, for reinforced belts or belts with little pretension required, we recommend the use of tensioning devices permanently installed on the conveyor system. Please follow our recommended pretension for each belt to reduce premature wear and failure on our bearings.

Common ways to properly tension a belt are listed below:

- cut the belt to a shorter length than the measured length of the conveyor system
- use a take up pulley or a deflection pulley with a counter weight or a mechanical screw movement
- the drive motor is moved in slotted mounting holes via an adjustment screw
- tensioning sled (the drive motor is mounted on rails and is moved by its own weight or by a screw mechanism)

- tensioning jack (the motor with the drive pulley is mounted on a turnable rocker. If the drive motor is running in the specified direction the backwards engine torque tensions the belt automatically)

The right positioning of tensioning pulleys is essential for the lifetime and functionality of a belt. The tensioning pulleys always should be located in the return strand right after the drive pulley

Recommended pretension for elastic belts



Quality	Shore	Thickness (mm)	max. Belt width									
			< 50 mm		< 100 mm		< 200 mm		< 400 mm		< 700 mm	
			Recommended pretension	applied pretension force = bearing load	Recommended pretension	applied pretension force = bearing load	Recommended pretension	applied pretension force = bearing load	Recommended pretension	applied pretension force = bearing load	Recommended pretension	applied pretension force = bearing load
%	N	%	N	%	N	%	N	%	N			
PU 65 A	72 A	1,6	4...5	64...80	3...5	96...160	3...5	192...320	1,5...5	192-640	0,7...5	156...1120
		2,0	4...5	80...100	3...5	120...200	2...5	160...400	1...5	160...800	0,7...5	196...1400
		3,0	4...5	120...150	3...5	100...300	1,5...5	180...600	0,7...5	168...1200	0,5...5	210...2100
PU 75 A	80 A	1,0	4...5	60...75	3...5	90...150	3...5	180...300	1,5...5	180...600	0,7...5	147...1050
		1,6	4...5	96...120	3...5	144...240	1,5...5	144...480	1...5	192...960	0,5...5	168...1680
		2,0	4...5	120...150	3...5	180...300	1,5...5	180...600	0,7...5	168...1200	0,5...5	210...2100
		3,0	4...5	180...225	2...5	180...450	1...5	180...900	0,5...5	180...1800	0,5...5	315...3150
PU 80 A	84 A	1,0	4...5	80...100	3...5	120...200	2...5	160...400	1...5	160...800	0,7...5	196...1400
		1,6	4...5	128...160	3...5	192...320	1,5...5	192...640	0,7...5	180...1280	0,5...5	224...2240
		2,0	4...5	160...200	2...5	160...400	1...5	160...800	0,5...5	160...1600	0,5...5	280...2800
		3,0	3...5	180...300	1,5...5	180...600	0,7...5	168...1200	0,5...5	240...2400	0,5...5	420...4200
PU 80 A SAFE	84 A	1,0	4...5	72...90	3...5	108...180	2...5	144...360	1...5	144...720	0,7...5	175...1260
		1,6	4...5	116...145	3...5	174...290	1,5...5	174...580	1...5	232...1160	0,5...5	203...2030
		2,0	4...5	144...180	2...5	144...360	1...5	144...720	0,5...5	144...1440	0,5...5	252...2520
PU 95 A	95 A	1,6	2...3	160...240	1...3	160...480	0,5...3	160...960	0,5...3	320...1920	0,5...3	560...3360
		2,0	1,5...3	150...300	1...3	200...600	0,5...3	200...1200	0,5...3	400...2400	0,5...3	700...4200
		3,0	1...3	150...450	0,5...3	150...900	0,5...3	300...1800	0,5...3	600...3600	0,5...3	1050...6300
TPE 55 D	55 D	2,0	1...3	200...600	0,5...3	200...1200	0,5...3	400...2400	0,5...3	800...3600	0,5...3	1400...6300
		3,0	0,5...3	150...900	0,5...3	300...1800	0,5...3	600...3600	0,5...3	1200...5400	0,5...3	2100...9450

Bearing load calculation (static)

Bearing load = tensile stress 1% k_b (kg/cm) x belt thickness (mm) x belt width (cm) x applied pretension (%) x 2

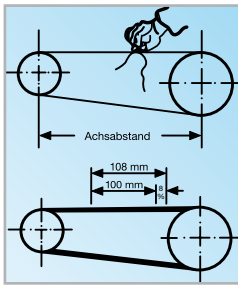

Working out the correct belt length

Use a string or steel tape to make measurements after reducing take-up (if installed) to the minimum. Distance between pulleys should remain fixed. To obtain good driving strength and good belt life, the belt pretension should be 0,5% to maximum 10%, based on hardness and length of the belt. To verify pretension on an installed belt, apply two marks with a pen separated by 10 inches (or 100 mm) on the belt when it is free from tension. The increase of space between the marks after mounting the belt in tenths of an inch (or mm) provides a measure of the pretension in percent.

Calculation of belt length

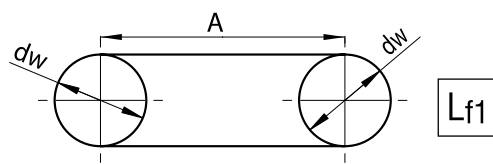

$$L_{f1} = dw \times \pi + 2 \times A$$

dw = effective diameter (position of the neutral axis of belt)
 A = center distance
for round belts: dw = bottom of groove + diameter of belt

The recommended pretension has to be considered in addition!

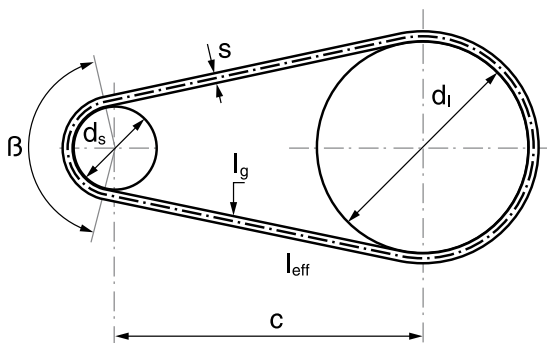

$$l_{eff} = 2c \cdot \sin\left(\frac{\beta}{2}\right) + \frac{\pi}{2} \left[d_s + d_i + 4s + \frac{(d_i - d_s)(180 - \beta)}{180} \right] \text{ [mm]}$$

c = center distance [mm]
 d_s = Diameter of the small pulley [mm]
 d_i = Diameter of the big pulley [mm]

The recommended pretension has to be considered in addition!

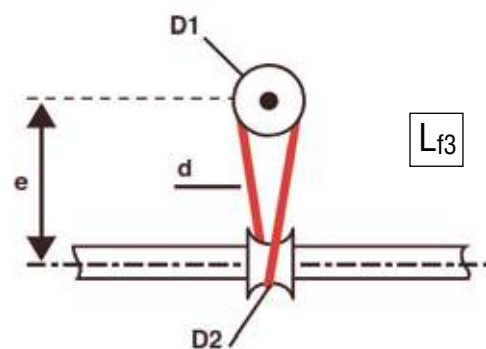

Lineshaft Conveyor Belts (semi-crossed)

$$L_{f3} = [(D1 + d) + (D2 + d)] \times \pi / 2 + 2 \times \sqrt{[(D1+d)^2 / 4 + e^2]}$$

$D1$: pulley diameter at bottom of groove
 $D2$: inner diameter of diabolo roller
 d : diameter of belt
 e : center distance

The recommended pretension has to be considered in addition!

Quick reference for V-Belts

Profile according to DIN 2215		6	8	10	13	17	22	32
Profile according to ISO 4184		Y	M	Z	A	B	C	D
Upper width w (mm)		6	8	10	13	17	22	32
Height h (mm)		4	5	6	8	11	14	20
Calculation of the belt length L_a and L_w if the inner length L_i is determined or known	$L_a = L_i +$	25	31	38	50	69	88	126
	$L_a = L_w +$	10	12	16	20	29	30	51
	$L_w = L_i +$	15	19	22	30	40	58	75
	$L_w = L_a -$	10	12	16	20	29	30	51



Coefficient of friction

Coefficient of friction μ for smooth surfaces (G)

Quality	Alu	Steel	Glass	Wood (veneer)	PE	HDPE
PU 60 A	0,95	0,90	0,75	0,80	0,55	0,50
PU 65 A	0,90	0,85	0,65	0,70	0,50	0,45
PU 70 A	0,85	0,75	0,60	0,70	0,40	0,35
PU 75 A	0,85	0,70	0,50	0,65	0,40	0,35
PU 80 A	0,80	0,65	0,45	0,60	0,35	0,30
PU 85 A	0,75	0,60	0,40	0,50	0,35	0,30
PU 85 A rau	0,55	0,45	0,45	0,45	0,30	0,25
PU 90 A	0,70	0,50	0,30	0,50	0,30	0,25
PU 95 A	0,65	0,45	0,25	0,45	0,25	0,20
TPE 40 D	0,70	0,50	0,30	0,45	0,25	0,20
TPE 55 D	0,45	0,35	0,30	0,35	0,20	0,15
TPE 63 D	0,45	0,35	0,30	0,35	0,20	0,15

Coefficient of friction μ flat belt surfaces on steel

Quality	Smooth gloss (SG)	Smooth matt (SM)	Fabric impression (IP)	Inverted diamond (ID)
PU 65 A	0,85	0,80	0,70	0,65
PU 75 A	0,70	0,65	0,55	0,50
PU 80 A	0,65	0,60	0,50	0,45
PU 95 A	0,45	0,40	0,30	0,25
TPE 55 D	0,35	0,30	0,25	0,20

V-belt dimensions according to DIN 2215 and ISO 4184

All V-belts are produced with a small radius at the edges

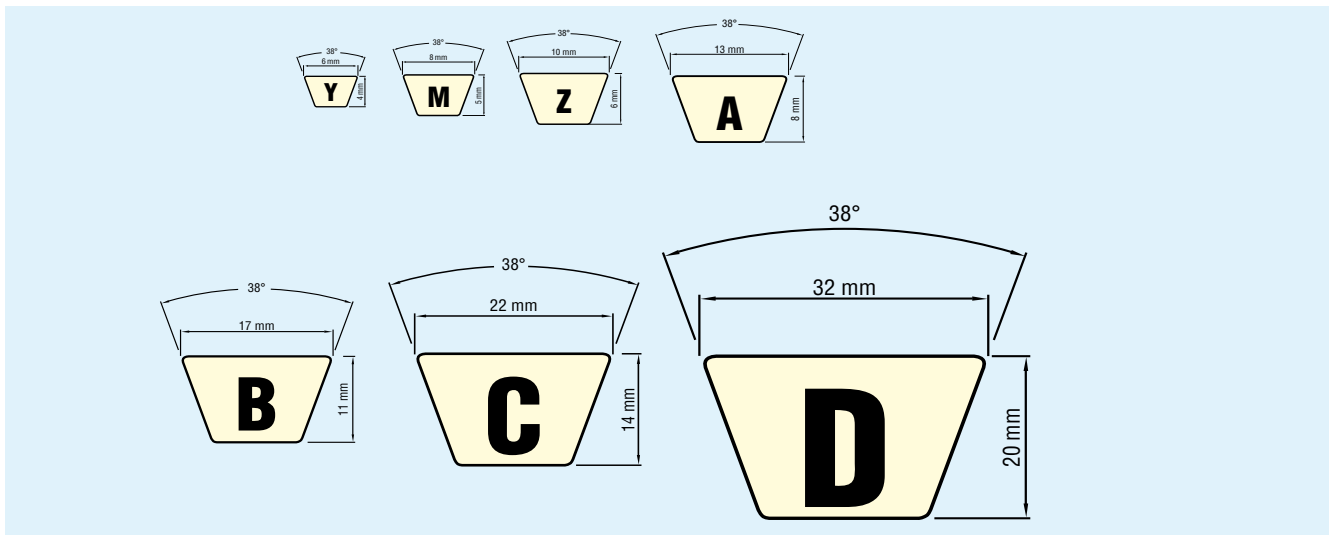

Calculation of round belt and V-belt cross section

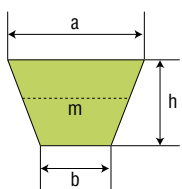

$$A_{cm^2} = \frac{a+b}{2} \times h = m \times h$$

$$m = \frac{a+b}{2}$$

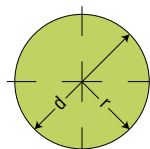

$$A_{cm^2} = \frac{\pi}{4} \times d^2 \approx 0,785 \times d^2$$

$$U = \pi \times d$$

Working tension for 1% elongation (k)

Profile

Quality	Shore	(k _p) kg/cm ²
PU 60 A	65A	0,60
PU 65 A	72A	1,00
PU 70 A	76A	1,25
PU 75 A (blue line)	80A	1,50
PU 75 A	80A	1,60
PU 75 A plus	80A	2,40
PU 80 A (blue line)	84A	1,90
PU 80 A	84A	2,00
PU 80 A SAFE	84A	2,00
PU 85 A (blue line)	88A	2,15
PU 85 A	88A	2,30
PU 85 A plus	88A	3,45
PU 85 A glas fiber	88A	10,00
PU 90 A	92A	4,80
PU 95 A	95A	5,00
TPE 40 D	40D	7,50
TPE 55 D	55D	10,00
TPE 63 D	63D	14,00

Flat belt (belt thickness 1,0mm)

Quality	Shore	(k _b) kg/cm
PU 65 A	72A	0,10
PU 75 A	80A	0,15
PU 80 A	84A	0,20
PU 80 A SAFE	84A	0,18
PU 95 A	95A	0,50
TPE 55 D	55D	1,00

Calculation formulas for max. loads of profiles and flat belts

max. load capacity (Profiles) =

$$\frac{\text{Tension 1\% } k_p \text{ (kg/cm}^2\text{)} \times \text{Material cross section (cm}^2\text{)} \times \text{Applied preload (\%)}}{\text{Coefficient of friction of running base } \mu}$$

max. load capacity (Flat belts) =

$$\frac{\text{Tension 1\% } k_b \text{ (kg/cm)} \times \text{Profile thickness (mm)} \times \text{Profile width (cm)} \times \text{Applied preload (\%)}}{\text{Coefficient of friction of running base } \mu}$$

max. tangential force (Profile) =

$$\text{Tension 1\% } k_p \text{ (kg/cm}^2\text{)} \times \text{Profile thickness (cm}^2\text{)} \times \text{Applied preload (\%)}$$

max. tangential force (Flat belts) =

$$\text{Tension 1\% } k_b \text{ (kg/cm)} \times \text{Profile thickness (mm)} \times \text{Profile width (cm)} \times \text{Applied preload (\%)}$$





Manufacturing tolerances

Manufacturing tolerances BEHbelt round- and V-belts/conveyor belts

Description	Dimesnion mm		Tolerance ≈ mm
Round belts			
Typ PU 75 A/80 A	∅ 2 - ∅ 8		± 0,2
Typ PU 75 A/80 A	∅ 9 - ∅ 15		± 0,3
Typ PU 85 A/90 A/95 A	∅ 2 - ∅ 8		± 0,2
Typ PU 85 A/90 A/95 A	∅ 9 - ∅ 15		± 0,3
Typ PU 85 A/90 A/95 A	∅ 18 - ∅ 20		± 0,5
Typ TPE 40 D/55 D	∅ 3 - ∅ 8		± 0,2
Typ TPE 40 D/55 D	∅ 9 - ∅ 15		± 0,3
Typ TPE 63 D	∅ 6,3, ∅ 9,5, ∅ 12,5		± 0,3

Round belts can be produced on request in “-” or “+”-tolerance.

Description	Dimesnion mm	(ISO)		Tolerance ≈ mm	
V-belts DIN 2215				0-Width	Height
Typ PU 65 A	6 - 8 - 10 - 13 - 17 - 22	(Y - M - Z - A - B - C)		- 0,5	+ 0,5
Typ PU 75 A	6 - 8 - 10 - 13 - 17 - 22 - 32	(Y - M - Z - A - B - C - D)		- 0,5	+ 0,5
Typ PU 80 A	6 - 8 - 10 - 13 - 17 - 22 - 32	(Y - M - Z - A - B - C - D)		- 0,5	+ 0,5
Typ PU 85 A	6 - 8 - 10 - 13 - 17 - 22 - 32	(Y - M - Z - A - B - C - D)		- 0,5	+ 0,5
Typ PU 90 A	8 - 10 - 13 - 17 - 22 - 32	(M - Z - A - B - C - D)		- 0,5	+ 0,5
Typ TPE 40 D	8 - 10 - 13 - 17 - 22	(M - Z - A - B - C)		- 0,5	+ 0,5
Typ TPE 55 D	8 - 10 - 13 - 17 - 22	(M - Z - A - B - C)		- 0,5	+ 0,5

Description	Dimesnion mm		Tolerance ≈ mm
Flat belt			
Belt thickness	1,0 / 1,6 / 2,0 / 3,0		+ / - 0,1
Belt width cut	700		+ / - 1,0

Manufacturing tolerances for tailoring

Production lengths (lf)	Tolerance
150 - 1000 mm	± 2 mm
1001 - 4000 mm	± 3 mm
4001 - 10000 mm	± 5 mm
over 10000	± 10 mm

Production lengths (lf)	Tolerance
< 10mm	± 0,2 mm
< 100mm	± 0,5 mm
> 100mm	± 1 mm

Weld thickness	Tolerance
1,0 / 1,6 / 2,0 / 3,0mm	± 10% of the belt thickness

Contact customer service if more strict tolerances are required

Manual lubrication is subject to many variables. You have to set up a fixed schedule and stick to that schedule. It is easy to forget about the schedule when you are busy. When you manually lubricate your equipment you run the additional risk of applying too much or not enough lubrication. Too much lubrication will cause over heating of the bearings. Too little lubrication will make the bearings run dry. With the high cost of lube oil and high costs of repairs and labour, analysis have shown that it is possible to reduce the overall cost of operating your equipment by using automatic lubricators. A steady oil flow is applied only when the bearing drive is running and thus avoids running dry and over lubrication.

LubeSite[®] automatic lubricator is characterised by:

- NO over- or under lubrication of the bearing
- Resulting in longer bearing life
- Cost savings both in labour and materials through longer lubricating Intervals
- Possibility to refill again with all lube oils (consistency 0...4 NLGI)
- Easy to maintain and environmentally-friendly construction
- Extensive program for nearly all applications

Application areas:

- Automotive industry
- Transport and aviation
- Car wash plant
- Wastewater treatment plant
- Feedingstuff production
- Fertiliser production
- Food industry
- Dairy production
- Printing plants
- Ceramic industry
- Paper manufactures
- Textile industry
- Wood industry
- Tobacco production
- Beverage production
- Mining industry
- Oil production
- Chemical plant
- Air conditioning systems
- Conveyor systems



Adapter



LubeSite[®] lubricators can be used for all antifriction units or fl oating bearings. The consistent lubrication of the bearing can be achieved by the spring pressure and the bevelled lengthwise slotted plunger.

A decreasing spring pressure on the aperture results in an increase at the plunger. Because of the low pressure (below 0,7 bar), the lubricant only flows when the bearing moves.

LubeSite[®] lubricators will help you lower your maintenance costs by replacing your manual lubrication with lubricators that can be refilled.

The refill interval depends on the application and bearing condition of each unit:

- small (Type 202, 302, 502) 3:1;
- medium (Type 205, 305, 505) 6:1;
- large (Type 260, 360, 560) 12:1.

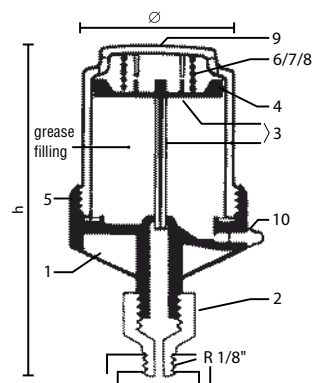

- 1 Body
- 2 screwed plug
- 3 Plunger and rod
- 4 O-tRing
- 5 Plunger and rod
- 6 Low spring
- 7 Medium spring
- 8 Strong spring
- 9 Clear case
- 10 Grease fitting



LubeSite[®] automatic refill lubricators

Light construction



LubeSite[®]-Series 200

LubeSite[®] 202, 205 and 260 within the clear-sight cages are the standard lubricators for most bearing applications.

They only supply lube oil, when the bearing is moving and therefore protect the bearing from over and under lubrication.

Units are assembled with medium sized springs. Three additional light and heavy springs are each included in a box of ten. Model 260 is delivered in a single package with additional springs (light, heavy).

Area of operation: -25...+120° C

Heavy construction



LubeSite[®]-Series 300

LubeSite[®] 302, 305 und 360 are designed for bearing housings which operate under static conditions, vibration and centrifugal forces. The strong metal castings compensate for the heavy loads.

The main application areas are eccentric presses, compactors, stone mills, construction machines, pumps, etc.

Units are delivered with medium sized springs. Three additional light and heavy springs each are included in a box of ten. Model 360 is delivered in a single package with additional springs (light, heavy).

Area of operation: -25...+120° C

For chemically aggressive media



LubeSite[®]-Series 500

LubeSite[®] 502, 505 and 560 is resistant to aggressive chemical agents. The light metal cases are made of special nickel-chrome double platens. The seals are plated with chemical resistant VITON.

The 500 series is a tried and tested product for many years in the chemical, food and nuclear industry.

Units are constructed with medium springs. Three additional light and heavy springs each are included in a box of ten.

Model 560 is delivered in a single package with additional springs (light, heavy)

Area of operation: -25...+120° C

For high temperatures



LubeSite[®]-Series 704

LubeSite[®] 704 is the only automatic lubricator on the market, that can be used in ambient and high temperature applications. The case is made of light metal, the body is made of borosilicate glass, the pressure spring is made of high quality steel and the sealing is made of temperature consistent VITON.

LubeSite[®] 704 is used with best results within roller mills, plants, dehumidifiers, etc. Model 704 is delivered in a single package with one additional heavy spring.

Area of operation: -25...+230° C

Technical data LubeSite[®] springs



	■ low	■ medium	■ strong	■ extra strong
Type	Spring resilience N tensioned/unstressed			
202, 205, 260	26/13 N 30/15 N 84/42 N	40/20 N 44/22 N 130/65 N	54/27 N 72/36 N 140/70 N	98/49 N 90/45 N 156/78 N
302, 305, 360	26/13 N 30/15 N 84/42 N	40/20 N 44/22 N 130/65 N	54/27 N 72/36 N 140/70 N	98/49 N 90/45 N 156/78 N
704	–	80/40 N	158/79 N	–

For further information,
please visit: www.behabelt.com

BEHA worldwide Group of companies

BEHAbelt USA Inc.
Wood Dale, IL, USA

SALES.



Beha Innovation GmbH
Glottertal, Germany

HEADQUARTER.



HDT Asia Ltd.
Hong Kong

LOGISTIC.



HDT GmbH
Glottertal,
Germany

HEADQUARTER.



Beha R&D d.o.o.
Belgrad, Serbia

DEVELOPMENT.



HDT (Dongguan) Ltd.
Kanton, V.R. China

PRODUCTION.



HDT

HDT – Your business partner for innovative electronic products

We develop electronic products from concept to manufacture. Together with you, the product management team at our head office in Glottertal, Germany defines products that will impress you both by their application as well as cost. Our development team in Glottertal and Belgrade, Serbia designs excellent technological solutions. We produce high quality at attractive prices in our factory in China.

Our customers are delighted and our competition – speechless!

We want our products to excite you: Users are fascinated by successful solutions that help them use the product. Our customers are happy with their rising sales figures. The competition tries to comprehend how our technology works.

What drives us is to develop and to produce unique products together with our customers.



**INDUSTRIE
PREIS 2014**
BEST OF



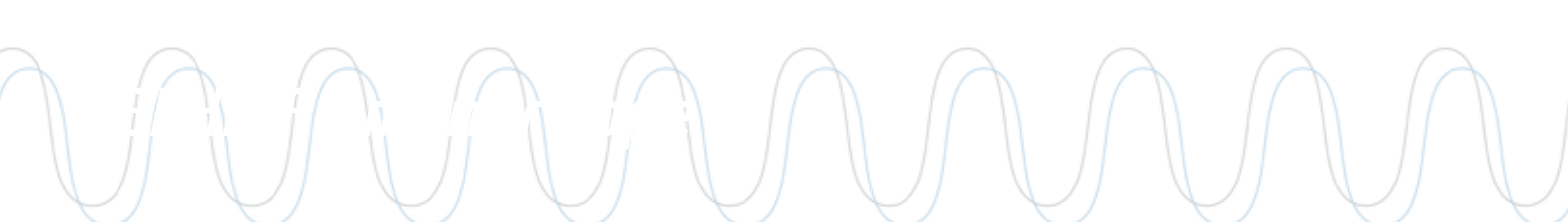

HDT manufactures your products. Personally and cost-consciously.

“Reducing costs in China can be very expensive.” That is the experience of our managing director, Holger Emberger, after working together with production facilities in low labour cost countries for over 15 years. High costs for communication, quality issues, and the danger of losing know-how quickly devour any savings.

It is precisely these disadvantages that HDT addresses: project managers in Germany who are well-versed with China are your point of contact. Our manufacturing facility near Hong Kong, HDT Dongguan, is a 100% subsidiary of the HDT Group. Our employees there, who have worked for us for years, are familiar with the requirements of European customers thanks to the many successful projects completed. HDT Group’s quality management department, based in Germany, has daily discussions regarding current issues with the QA Team in Dongguan and also visits the facility regularly. Besides that, we have a monthly external audit carried out by certification authorities such as TÜV, SGS and CSA as well as by our customers.



From concept to development and mass production: HDT works with you to make your product a reality



reddot award 2014
honourable mention



No space for innovations: the products are mature but the market prices are at rock bottom. Ideas for product improvement appear to be inadequate. Development budgets are low. The timeline for achieving growth targets slips further into the future. Almost every person responsible for a product knows this feeling of helplessness.

HDT has specialised in innovations for mature markets. We develop products that create hype and open market opportunities. This is apparent in the market success of our developments as well as the accolades they receive, such as the Red Dot Award in 2014.

Facts and figures

Full service provider of electric and electronic innovations, OEM portfolio, customer-specific products, contract manufacture, Part of the BEHA Group with 40 years of experience in the development and manufacture of electronic products

Headquarters: Glottertal, Germany

Development team: 20

Total number of employees: 85

Manufacturing sites: Glottertal, Germany (up to 1,000 units/year) and Dongguan, China (over 1,000 units/year)

ISO 9001 certified

www.hdt-electronic.com



Much more than contract development and manufacturing

“We are a family-owned enterprise that puts great emphasis on strong partnerships, reliability, quality and sustainability – and we are convinced that long-term cooperation results in better outcomes.

„Linking people and technology“ is our slogan; it reflects our actions, which are aimed towards developing innovative solutions that simplify the user’s work – as well as making your company more successful,” says Lars Christian Beha, managing director of HDT.

BEHAbelt profiles are available at your specialist dealer or our area representatives

Your specialist dealer / system supplier

PBEPM0000090 · 03/15

BEHA Innovation GmbH

In den Engematten 16 · 79286 Glottertal/Germany
Phone: +49 (0) 76 84 / 907 - 0 · Fax: +49 (0) 76 84 / 907 - 101
E-Mail: info@behabelt.com · Internet: www.behabelt.com

